



HAL
open science

Thermoelectric Power Generators: State-of-the-Art, Heat Recovery Method, and Challenges

Rima Aridi, Jalal Faraj, Samer Ali, Thierry Lemenand, Mahmoud Khaled

► **To cite this version:**

Rima Aridi, Jalal Faraj, Samer Ali, Thierry Lemenand, Mahmoud Khaled. Thermoelectric Power Generators: State-of-the-Art, Heat Recovery Method, and Challenges. *Electricity*, 2021, 2 (3), pp.359-386. 10.3390/electricity2030022 . hal-03457776

HAL Id: hal-03457776

<https://univ-angers.hal.science/hal-03457776>

Submitted on 15 Feb 2023

HAL is a multi-disciplinary open access archive for the deposit and dissemination of scientific research documents, whether they are published or not. The documents may come from teaching and research institutions in France or abroad, or from public or private research centers.

L'archive ouverte pluridisciplinaire **HAL**, est destinée au dépôt et à la diffusion de documents scientifiques de niveau recherche, publiés ou non, émanant des établissements d'enseignement et de recherche français ou étrangers, des laboratoires publics ou privés.



Distributed under a Creative Commons Attribution 4.0 International License

Review

Thermoelectric Power Generators: State-of-the-Art, Heat Recovery Method, and Challenges

Rima Aridi ^{1,2}, Jalal Faraj ^{2,3}, Samer Ali ⁴, Thierry Lemenand ¹ and Mahmoud Khaled ^{2,5,*} 

¹ Laboratoire Angevin de Recherche en Ingénierie des Systems (LARIS) 7315, Polytech Angers, University of Angers, 49000 Angers, France; rima.alaridi@etud.univ-angers.fr (R.A.); thierry.lemenand@univ-angers.fr (T.L.)

² Energy and Thermo-Fluid Group, International University of Beirut (BIU), Beirut 146404, Lebanon; jalal.faraj@liu.edu.lb

³ Faculty of Technology, Lebanese University (LU), Saida 1600, Lebanon

⁴ Energy and Thermo-Fluid Group, Lebanese International University (LIU), Bekaa 1803, Lebanon; samer.ali@liu.edu.lb

⁵ Interdisciplinary Energy Research Institute (PIERI), University Paris Diderot, Sorbonne Paris Cité, 75000 Paris, France

* Correspondence: mahmoud.khaled@liu.edu.lb; Tel.: +961-7180-7989

Abstract: Electricity plays a significant role in daily life and is the main component of countless applications. Thus, ongoing research is necessary to improve the existing approaches, or find new approaches, to enhancing power generation. The thermoelectric generator (TEG) is among the notable and widespread technologies used to produce electricity, and converts waste energy into electrical energy using the Seebeck effect. Due to the Seebeck effect, temperature change can be turned into electrical energy; hence, a TEG can be applied whenever there is a temperature difference. The present paper presents the theoretical background of the TEG, in addition to a comprehensive review of the TEG and its implementation in various fields. This paper also sheds light on the new technologies of the TEG and their related challenges. Notably, it was found that the TEG is efficient in hybrid heat recovery systems, such as the phase change material (PCM), heat pipe (HP), and proton exchange membrane (PEM), and the efficiency of the TEG has increased due to a set of improvements in the TEG's materials. Moreover, results show that the TEG technology has been frequently applied in recent years, and all of the investigated papers agree that the TEG is a promising technology in power generation and heat recovery systems.

Keywords: power generation; heat recovery; thermoelectric generator; gradient temperature; wasted heat



Citation: Aridi, R.; Faraj, J.; Ali, S.; Lemenand, T.; Khaled, M.

Thermoelectric Power Generators: State-of-the-Art, Heat Recovery Method, and Challenges. *Electricity* **2021**, *2*, 359–386. <https://doi.org/10.3390/electricity2030022>

Academic Editor: Marco Noro

Received: 10 June 2021

Accepted: 30 July 2021

Published: 16 September 2021

Publisher's Note: MDPI stays neutral with regard to jurisdictional claims in published maps and institutional affiliations.



Copyright: © 2021 by the authors. Licensee MDPI, Basel, Switzerland. This article is an open access article distributed under the terms and conditions of the Creative Commons Attribution (CC BY) license (<https://creativecommons.org/licenses/by/4.0/>).

1. Introduction

Electricity is one of humankind's most significant scientific discoveries and is now integral to our daily lives. In addition, the development of electricity is an essential milestone in scientific progress, and ongoing research aims to identify new electrical energy sources or improve the existing methods of generating electricity [1,2]. The crucial role of electricity and the necessity to be environmentally friendly have encouraged investments in the use of green resources and waste energy for generating electricity [3–5]. These ambient energy sources are considered to be accessible sources of energy, and are classified into two categories: natural energy and energy recovery resources.

1. Natural energy comprises several sources of energy that can be transformed into electricity, as presented in Figure 1. For instance, wind, hydro energy, waves, and mechanical vibration [6,7] create motion that can be converted into electrical energy using the piezoelectric effect or turbines. Similarly, the temperature gradient, chemical energy, electromagnetic radiation, and light are forms of green energy that can be used to generate electricity via thermoelectric generators (TEGs), and the reaction,

induction, and photoelectric effects, respectively. Renewable energy sources constitute 25% of the power generation sector, and this proportion is expected to increase to 85% by 2050 [8];

2. Energy recovery resources comprise waste energy, in the form of kinetic energy or heat from applications, that is recovered and reused. The related approaches include flue gas heat recovery, the recovery of kinetic energy using a flywheel, and hybrid pneumatic power systems. Thus, the main advantage of these systems is the recovery of waste energy that would otherwise be lost.

In general, renewable energy and other applications or systems are integrated with energy recovery systems. Thus, the energy lost from the primary system is captured and reused. This method creates a new source of reliable, clean, renewable, regenerated, and environmentally friendly energy that produces minimal waste products. As a result, these renewable energy recovery systems have an advantage compared to non-renewable power plants [9,10], which are not favored because they create pollution and gradually deplete resources. However, the disadvantages of free sources of energy are their low efficiency, their complete reliance on weather conditions and geographical location, as well as the unpredictability of the ambient energy source [11].

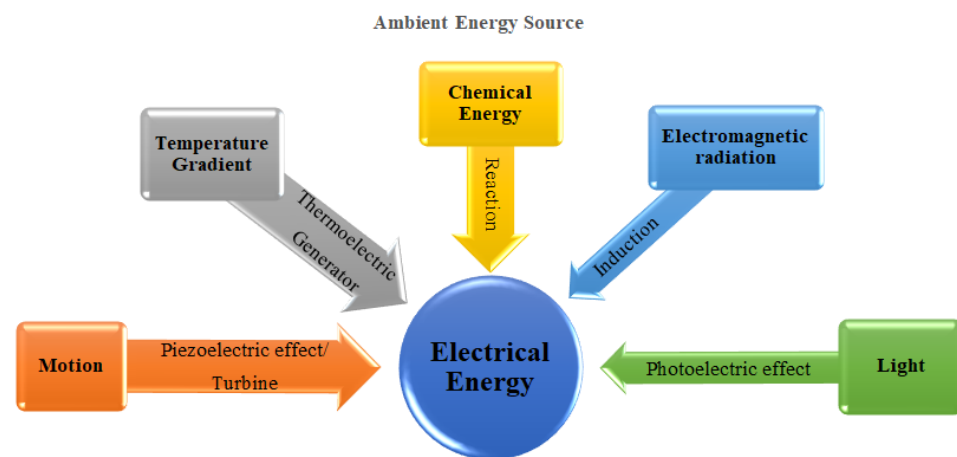

Figure 1. Ambient energy sources converted into electricity.

Due to the increase in energy demand, energy harvesting methods have gained significant interest and should be considered in most energy applications. Engineers and researchers are escalating their efforts to identify new sources of energy that are simple to use and productive. When it is able to be recovered, waste energy, such as heat energy, is considered to be an alternative source for the production of electricity. This is of particular interest because the percentage of waste energy is significant, as shown in Figure 2. For example, in the energy consumption of vehicles and automobiles, around 36% of the input energy is lost as heat from the internal combustion engine, about 38% is lost in the exhaust, and 6% is lost as friction [12]. In addition, the energy loss of power plants is 60% prior to applying heat recovery [13]. A considerable percentage of energy is also lost through the condenser in heating, ventilation, and air-conditioning (HVAC) systems. Thus, the percentage of waste energy differs depending on the use. In each of these uses, recovering the energy so that it can be reused in the same application or in another way (i.e., another application) is crucial.

So, as noticed, energy is not the problem, but rather sustainability is. With that being said, this problem can be solved through energy recovering units (ERU). Recently, ERU is a must in most applications due to its effectiveness in saving and recovering the lost energy.

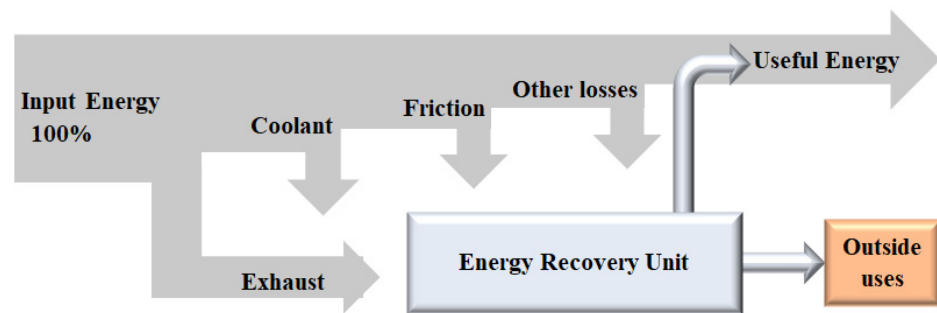

Figure 2. Schematic of waste energy in most applications.

A thermoelectric generator (TEG) is one of the existing tools used to recover wasted heat. The main advantage of TEG over other heat recovery devices is that it is applicable for small-scale discrete energy sources. TEG contains no moving parts, making it noiseless; and it is known for its simplicity, low cost, and effectiveness when used for applications with low temperatures. However, TEG has low efficiency, wherein it does not exceed 7% [14,15]. TEG performance is related to two main factors: (1) Material's thermoelectric properties, which affects the efficiency of TEG [16], and (2) temperature gradient, which is related to sink's mass flow rate and heat source, properties of flowing fluid, inlet temperature, and the heat exchangers design [17].

The scientific concern is not to just increase the efficiency; however, the challenge of using TEG is to find a suitable gradient temperature proportional to the electrical energy produced. This paper presents a comprehensive review of the theoretical background and development of TEG over the years, as well as, it investigates around 180 published papers to study the effectiveness of TEGs in various applications. Furthermore, this review straightens out the challenges that the researchers have faced throughout the development of thermoelectric devices (TED).

Scope of the Paper

Among the recent review papers, it is noticed that TEGs are highly recognized for research projects, where the review papers tend to investigate TEGs from various aspects, such as Zoui et al. [18], who conducted a review on the progress and applications of TEG; Kumar et al. [19], who held a review about TEG design and its medical applications; and likewise, Indira et al. [20], who took a review on several dispositions of hybrid concentrator photovoltaic (CPV) and TEG systems.

Although the mentioned papers have indeed reviewed TEG through different aspects, there was a lack of information about the exact starting time of TEGs' applications and the challenges that they have faced. Hence, the novelty of the recent review is:

1. Presenting the history of main milestones that TEG passes through since its first invention;
2. Displaying the applications of thermoelectric (TE) in the past, starting from 1985, and the expectations of TE applications for the foreseeable future, specifically 2030;
3. Reviewing over 180 papers and classifying them into specific categories;
4. Demonstrating the challenges that the researchers have faced during the study. This section is crucial as it is noticed that the progress of TEG development was by working on solving the challenges of the previous studies.

2. Theoretical Background

The thermoelectric effect was first discovered in 1822 by Thomas Johann Seebeck, who discovered that a thermal gradient formed between two dissimilar conductors produces a voltage. At the heart of the thermoelectric effect is that a temperature gradient in a conducting material results in heat flow, which results in the diffusion of charge carriers. The flow of charge carriers between the hot and cold regions, in turn, creates a voltage difference. The output produced was initially a small magnitude and was of no value in

electric power generation [21]. With the discovery of semiconductors, it was found that the output could be magnified significantly, and new concerns arose in the middle of the 20th century.

Conversion between thermal and electrical energy occurs due to three main thermoelectric phenomena: the Seebeck effect [22], the Peltier effect [23], and the Thomson effect [24]. The Seebeck effect is the conversion of a temperature gradient to electricity; the Peltier effect indicates that an electric current would generate temperature difference at the joint of two different materials, and the Thomson effect is an extension to the Peltier–Seebeck model [25,26]. In conclusion, in the Peltier effect, the current is the driving work to heat, whereas in Seebeck, the difference in heat is the driving work to current.

2.1. Seebeck Effect

In 1821, the German physicist Thomas Johann Seebeck (1770–1831) [27] discovered that the needle of a compass would be deflected by a loop made from two linked materials of different temperatures: cold temperature (T_c) and hot temperature (T_h) between the joints [28]. This deflection is due to the different responses of the materials to the gradient temperature, creating a current and magnetic field through the loop. Thus, the Seebeck effect refers to the presence of a potential electric current through a thermoelectric material when subjected to a temperature difference [27,29].

In this section, three main terms are described and demonstrated as follows: (1) the link between two dissimilar metals is called a thermocouple, (2) electromotive force (emf) produced in a thermocouple is called thermo emf, and (3) the current that flows through the closed circuit is called thermoelectric current.

For a specific range of temperature and different material combinations, thermo emf is different. The direction and magnitude of thermo emf are related to the nature of the materials used in thermocouples ΔT between hot and cold junctions. Thus, Seebeck organized a series of 35 metals between 0 and 100, so that the current flows over the cold junctions from the metal put first to the one put later. A selection from Seebeck's series showing the symbol of the element with its atomic number and mass is organized as shown in Figure 3 [30]. The larger the distance between the two chosen metals, the higher thermo emf will be obtained; this is why TEG of Bismuth telluride base is mainly used [31,32].

83	28	78	29	25	89	82	50	79	47	30	48	26	51	52
Bi	Ni	Pt	Cu	Mn	Hg	Pb	Sn	Au	Ag	Zn	Cd	Fe	Sb	Te
208.98	58.69	195.08	63.55	54.93	200.59	207.2	118.71	196.97	107.87	65.38	112.41	55.84	121.76	127.6

Figure 3. Thermoelectric series [30].

2.2. Peltier Effect

The Peltier effect was revealed in 1834 by the French physicist Jean Charles Athanase Peltier (1785–1865). He discovered that applying current at a junction between two different materials leads to the release and absorption of heat, as shown in Figure 4. At the atomic level, this is due to the different energy states of materials, which are P- and N-type materials. As electrons shift from P-type to N-type material, they reach a higher energy level, leading to absorption of heat from the surroundings. On the other side, as electrons shift from N-type to P-type material, electrons break down into the lower energy level, leading to releasing heat to the surrounding. So, the Peltier effect is related to heat absorption on one end of a thermoelectric material, and heat release from the other end due to the current flow over the material, as shown in Figure 4 [33]. If the current direction is inverted in the thermocouple, the absorbed or evolved heat is exchanged, consequently Peltier effect is reversed.

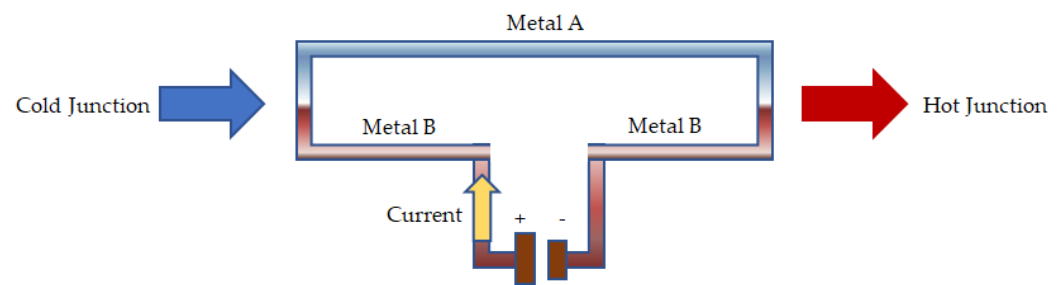

Figure 4. Peltier effect [33].

2.3. Thomson Effect

The Thomson effect was developed by William Thomson (1824–1907), better known as Lord Kelvin, who stated in 1851 that as a current passes along the length of the same metal from one cold end to the other hot end or vice versa, absorption and evolution of heat would occur as shown in Figure 5 [34]. The amount of heat energy evolved and absorbed when a current of 1 A (one ampere) passes through a metal between two points of temperature difference $\Delta T = 1\text{ }^\circ\text{C}$, is called the Thomson Coefficient τ .

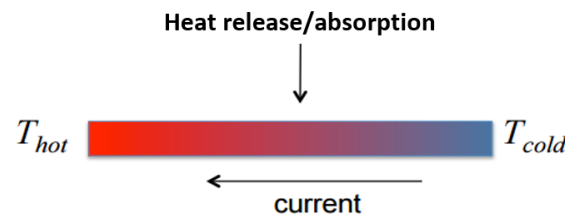

Figure 5. Thomson’s effect [34].

Thomson’s effect undergoes three different cases: positive, negative, or null. These effects are related to the materials used, as shown in Table 1.

Table 1. Definition and examples on Thomson’s three different effects [35,36].

Thomson’s positive effect	When the current passes from the hot end to the cold end, the heat is developed, so the conductor becomes hot.
	When the current passes from the cold end to the hot end, the heat is absorbed, so the conductor becomes cold.
	Antimony, Silver, Zinc, Cadmium
Thomson’s negative effect	When the current passes from the hot end to the cold end, the heat is absorbed, so the conductor becomes cold.
	When the current passes from the cold end to the hot end, the heat is evolved, so the conductor becomes hot.
	Platinum, Bismuth, Cobalt, Nickel, Mercury.
Thomson’s null effect	Used for the standard metal in thermoelectricity.
	Lead

2.4. Thermoelectric Generators Working Process

A thermoelectric generator (TEG) is a solid-state device that converts heat energy into electrical energy using the Seebeck effect. TEG is obtained by a cascade connection of multiple thermocouples. TE materials’ performance is obtained by three thermoelectric properties: Seebeck coefficient α , electrical resistivity ρ , and thermal conductivity K [37]. TEG’s design is based on the Seebeck effect in which temperature gradient between the current-carrying conductors P- and N-types of semiconductors produce a voltage ΔV [38].

The thermoelectric semiconductor has two main components: P-type, which holds free holes, and N-type, which holds electrons. In P-type, due to temperature gradient, the holes move from the hot side to the cold side (low density of holes to higher density), which causes a density charge difference [39]. This density charge difference will repel electrons to the hot side, as illustrated in Figure 6 [40]. During the steady-state, the charge density difference will be adjusted by temperature difference. Emf generated across the material, which causes electrical current, is called Seebeck voltage. The formed voltage is proportional to ΔT by the Seebeck coefficient. N-type semiconductors follow the same effect, however, the heat and charge carriers are electrons rather than holes [41]. Electrons will move towards the cold side, which becomes negatively charged, as shown in Figure 7 [42,43]. Now, if the hot sides are connected electrically and the cold sides are linked by a load, a current would be created, and it would pass over the load. The higher heat flow from the hot to the cold side will increase the current flow [44].

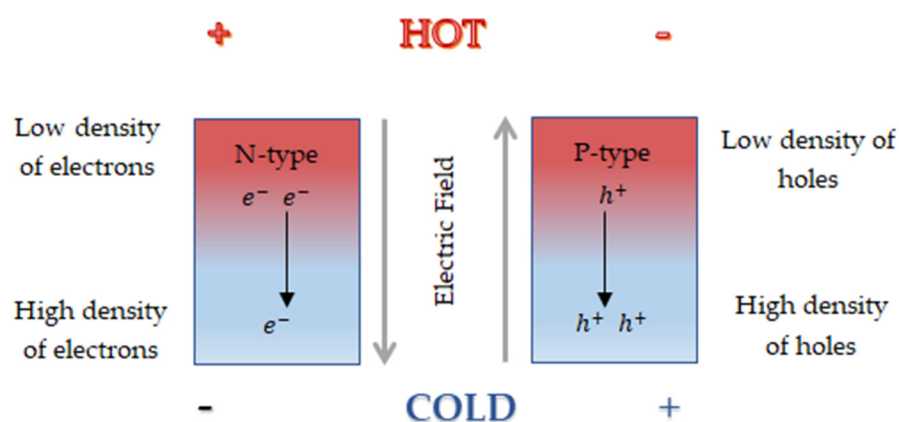

Figure 6. Charge carrier movement [39,40].

Accordingly, thermoelectric modules can be used in two different modes [45,46]:

1. Power generation mode to produce electricity, which is called thermoelectric generator (TEG) and follows Seebeck effect, shown in Figure 7a [47];
2. Active refrigeration mode (temperature controller), which is called thermoelectric cooler (TEC) and follows Peltier effect, shown in Figure 7b [48,49].

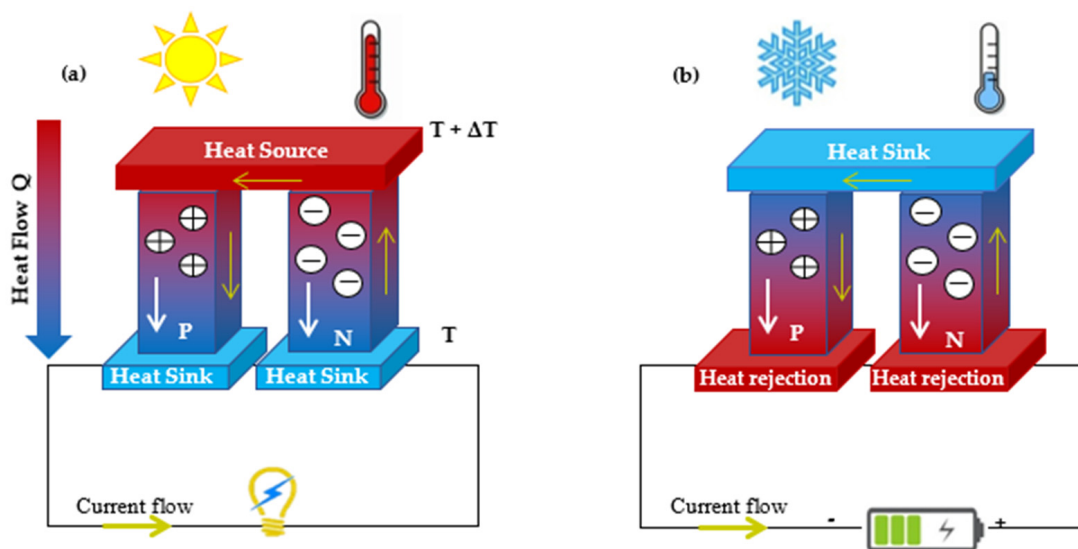

Figure 7. (a) Power generation mode TEG [49] and (b) active refrigeration mode TEC setups [47].

More N-P type pairs should be connected in series to obtain higher output voltage, as shown in Figure 8. A thermoelectric module, illustrated in Figure 8, is formed when P and N legs are connected electrically in series and thermally in parallel. The thermoelectric elements N- and P-types carry the current, whereas the couple made out of the two conductors is called a thermoelectric couple.

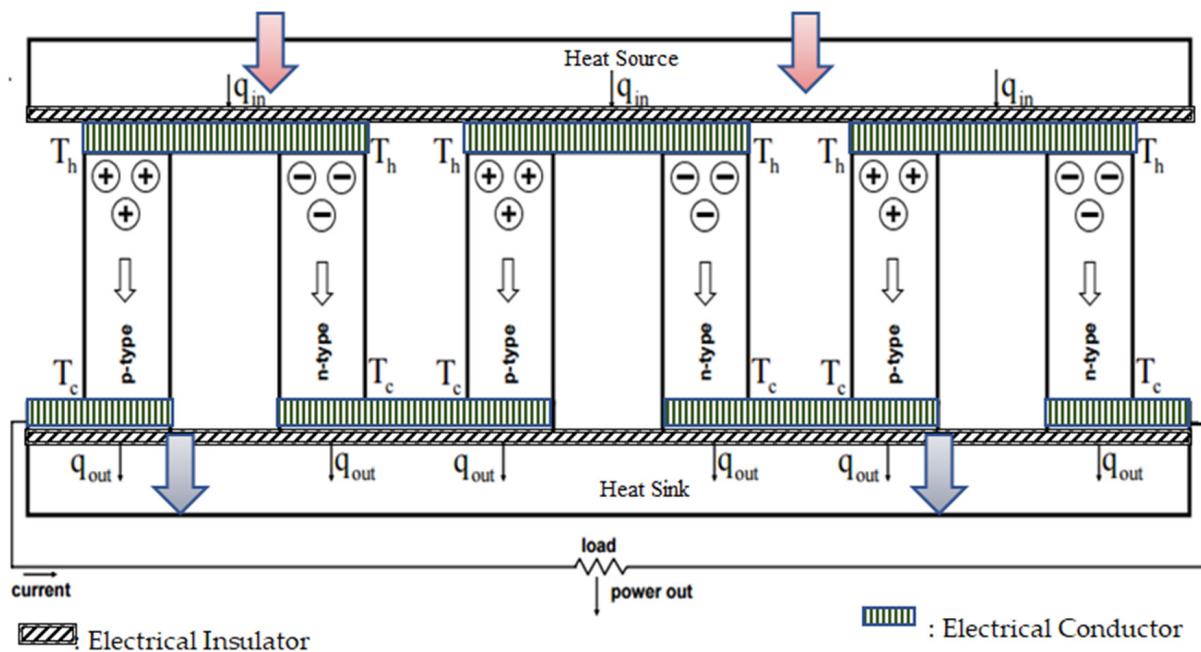

Figure 8. Thermoelectric cell composed of different thermocouples [50].

2.5. Figure of Merit (ZT)

The efficiency of a TEG is proportional to a dimensionless parameter called the figure of merit (ZT), which was developed in 1949 by the Russian scientist Abram Fedorovich Ioffe (1880–1960) [51,52]. ZT indicates the total performance of TEG, which is optimized when ZT is maximized. A good thermoelectric material should have a high Seebeck coefficient, high figure of merit, and low thermal conductivity K and resistivity. Thus, both a high figure of merit of materials and high-temperature differences are preferred to attain high efficiency. Since the material's thermoelectric properties, which are Seebeck coefficient α , electrical resistivity ρ , and thermal conductivity K fluctuate with temperature, it is not practical to utilize identical material through an absolute high-temperature difference. To reach an approximate ideal state, dissimilar high efficient materials are used to segment the first material at a higher temperature with the second material at a lower temperature. Through this approach, both materials are functioning in their utmost efficient range of temperature [53].

3. Historical Notes

As mentioned previously, TEG is capable of generating electricity and providing a source of cooling and heating. The high interest in research in improving TEG is dissipated through the past years. Figure 9 shows the milestones of TEG, which means the innovation, addition, or development of TEG that remarkably affects the development of TEG and the direction of its spreading in applications. Table 2 shows the chronological history of TEG development since the discovery of Seebeck, where the effect of the milestones is remarkably noticed through the applications that follow each new development.

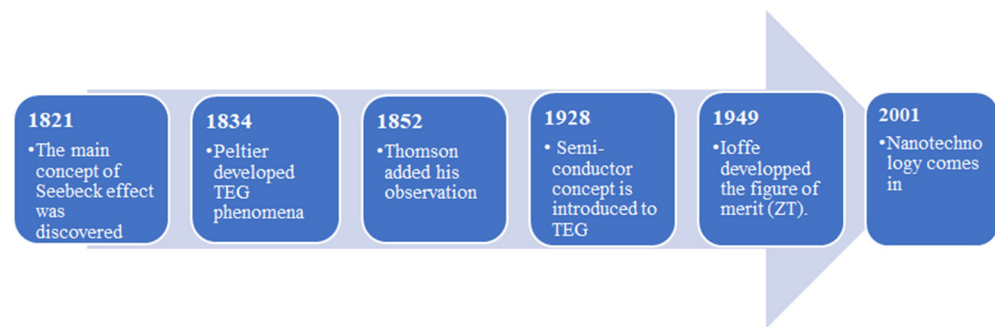

Figure 9. Milestone of TEG since it was discovered.

Table 2. Development of TEG in chronological order.

Year	Research Finding
1821	The main concept of Seebeck effect was discovered [54]
1834	Peltier developed TEG phenomena [55]
1852	Thomson added his observation [54]
1909	Altenkirch stated that mathematically, the relationship between the physical properties of thermoelectric materials and the efficiency of a simple TEG [52].
1911	Altenkirch (1880–1953) initiated the concept of maximum efficiency of TEG and the performance of a cooler
1928	Semiconductor concept is introduced in thermoelectric energy [56]
1930	The first thermoelectric operated radio was stated [56]
1947	Maria Telkes (1900–1995) built the first thermoelectric power generation of a 5% efficiency [56]
1949	Abram Fedorovich Ioffe developed the figure of merit (ZT) [52]
1954	H. Julian Goldsmid froze to 0 °C a surface by a TE Peltier cooler using Bismuth telluride (Bi_2Te_3) [56]
1968	The first radioisotope ISNAP19 TEG flew on a NASA spacecraft due to its reliability and remote power generation. Another TE SNAP generator was prepared to travel to the moon in the following year [56].
1970 *	The healthcare company “Medtronic” prolonged the use of TEGs in the biomedical sector [57].
1970	Medtronic has developed the first cardiac pacemaker driven by a TEG and was implanted into a human in France [56].
1972	Units of TE cooling were established in Japan for Satellite Communication Ground [58].
1975	Lead Telluride (PbTe) TEG technology was formed to generate terrestrial power remotely, forming Global TEG [56].
1977	NASA used MHW-RTG3, a Silicon Germanium (SiGe) TEG, to power two voyagers 1 and 2 [56].
2001	A noteworthy stepped forward in TEG by introducing nanotechnology scale materials [56,59]
2004	TEG was integrated into automotive through a program fund by the US Department of Energy and General Motors, like Caterpillar, BMW, and others [56,60]
2005 *	TEG for Industrial Waste Heat Recovery (WHR) was developed [61]
2006 *	Flexible TEG technology [62]
2013	Voyager 1 developed the first manmade piece powered continuously by TEG to depart the solar system and go into interstellar [56].

* There was no specific year for introducing nanotechnology or flexible TEG; the years were obtained by going back to all review papers related to nanotechnology and polymers for TEG and find the first time they were mentioned.

Table 2 shows that TEGs have been spread widely and developed dramatically, especially after each milestone. These remarkable events and innovative ideas opened the opportunity for new fields and added value to the TEGs’ development, where TEG development helped in being more involved in applications. In addition, the spread of TEGs in applications allows the research to go further in developing TEG materials.

As shown previously, TEG technologies had exhibited a high share in the research work on the theoretical and experimental scales [63]. For instance, in 2004, Crane et al. [64]

conducted an experiment by investigating the heat transfer over TEG and expecting the electric and contact resistance. A counter flow liquid to the air system was applied for thermoelectric heat recovery. The model entailed an aluminum tube for the hot water to flow with three TEG modules that were directly contacted. This research concludes that the temperature of fluid and air affect the output power of the TEGs system. A heat exchanger of counter flow system that transfers heat from the liquid to air was applied, where a hot fluid is pumped inside the tube and the cooled air is blown through the heat exchanger. The model entailed an aluminum tube for the hot water to flow with three, directly contacted TEG modules. This research concludes that the temperature of fluid and air affect the output power of the TEGs system.

Nowadays, TEG is requested by many industrial sectors, where it fills great needs in the military [65], sensors [66], and cars [67]. In addition, TEG has gained a significant standard, especially after being integrated into nanotechnology or the medical domain [68]. TEG is also used for running personal electronics through body heat, such as mobile phones and wearable sensor systems [18]. It must be mentioned that TEGs are also used as heat pumps or as generators in domestic plants for air conditioning or heating [69].

Parallel to integrating TEG in useful applications, research on TEG is still in progress. However, it is directed towards going further beyond performance level by either increasing the gradient temperature such as TEG, finding any source of wasted heat or increasing the efficiency, which means editing the material used.

TEG is expected to expand its application in industrial instrumentations. In the USA, there is a strategy to apply TEG in automobile industries. By working more on the molecular level of TEG and trying to increase the figure of merit, thermoelectric device (TED) will have considerable potential in much more regions of applications.

4. TEG in Applications and Classifications

Despite being less efficient than mechanical heat engines on ample output power, TEG takes the lead when it comes to small output power somewhere less than 100 W. Moreover, TEG's simplicity, unmatched dependability, and durability make it a substantial and valuable device in various applications, where the aim is unattended operations rather than efficiency. These applications include power supplies for spacecraft that operate too far from the sun to take advantage of the photovoltaic effect, or automotive uses that take advantage of the heat that engines shed, or generators for oil-producing installations, including ocean platforms. In addition, being fully quiet is a virtue of the TEDs in many cases, where noise would be disturbing or as intolerable as aboard submarines.

Considerably, TEGs have been widely used throughout commercial and industrial levels. Starting from watches, automobiles, and ending in spacecraft [70]. A great example of a low power thermoelectric generator application that ranges between 5 μ W to 1 W would be the thermoelectric wristwatch, which uses thin bulk TEDs; the watch works by converting body heat into electrical power through TEG. At least two models have been built, one by Seiko and another by Citizen. Internationally, there is a wide variety of commercial and custom-made TEGs, such as micro TEGs that generate low power energy, wearable devices, body-mounted devices, thin-film TEGs, which use solid-state semiconductors that are compatible with microelectromechanical systems (MEMS) [71]. A. S. Korotkov [72] conducted a study on TEGs types and classified TEGs into bulk and thin-film TEGs. The paper presented the main advantage of TEGs employed in MEMS, where the specific power (power per unit area, P/S) is elevated by around 3 to 5 times more than that of bulk TEGs. Thin-film TEG technology has shown promising outcomes and gotten the attention of the researchers through different studies [73], consequently helped it spread widely over low applications in various fields, such as wearable devices, electronics, sensors, and others [74]. However, high power generations that generate about 1 kW are involved in larger applications, such as the automotive field (BMW [75], Volkswagen [76], Volvo, and others [18]), where TEG can extract waste heat from the exhaust that delivers DC electrical power to recharge the battery. By reducing or even eliminating the need for

the alternator, the load on the engine is reduced. This improves fuel efficiency by around 10%. For instance, a TEG system integrated into a semi-truck automotive system may produce a power of 1.25 kW, representing 20% of the engine's power need [77].

In addition, a TEG with 1.25 ZT and 10% efficiency might be utilized to retrieve 35–40% of the energy from the exhaust. It manifolds at an average temperature of 250 °C, where a significant energy value can be produced to contribute up to a 16% escalation in efficiency [49]. Researches have shown high interest in TEG, where many researchers have investigated applications using TEG [78,79], such as being integrated into cooling applications [80], computational modeling [81], and parametric changes [82]. It was also used as a hybrid system with all-air HVAC systems [83] or solar photovoltaic [84,85].

According to the investigated papers, TEG was used in various applications. Figure 10 classifies the use of TEG according to three main categories:

1. TEG in applications: TEG has been publicized widely and rapidly in various fields, electronics, vehicles, industries, and renewable energy;
2. TEG in hybrid systems: according to the studied papers, TEG has a considerable share when involved with other energy recovery systems such as storage, piezoelectric, and heat exchangers;
3. Design and material improvement: research has also discussed the design and material development to reach an optimum output of a TEG unit.

This review studied over 180 published papers, starting from 2008 to 2021. The studied papers are classified TEG with four categories: integrated with building and vehicles, material development (MD), installed with other heat recovery methods (hybrid heat recovery), and joined with electronics or renewable energy. Figure 11 shows the number of investigated papers according to years and the above-mentioned categories.

As shown in Figure 11, TEG has been well-known in various fields, especially combined with renewable energy and electronics and buildings and vehicles that have a high share in the studied papers. In addition, TEG installed with other heat recovery methods, such as phase change material (PCM) [86], heat pipe (HP) [87], proton exchange membrane (PEM) [88] started to grow noticeably; which means that it is worthwhile to investigate it, even more especially with other heat recovery methods. Among the investigated papers, it is noticed that TEG with HE is well known and employed in different applications, which leads to the introduction of TEG with other HE technologies.

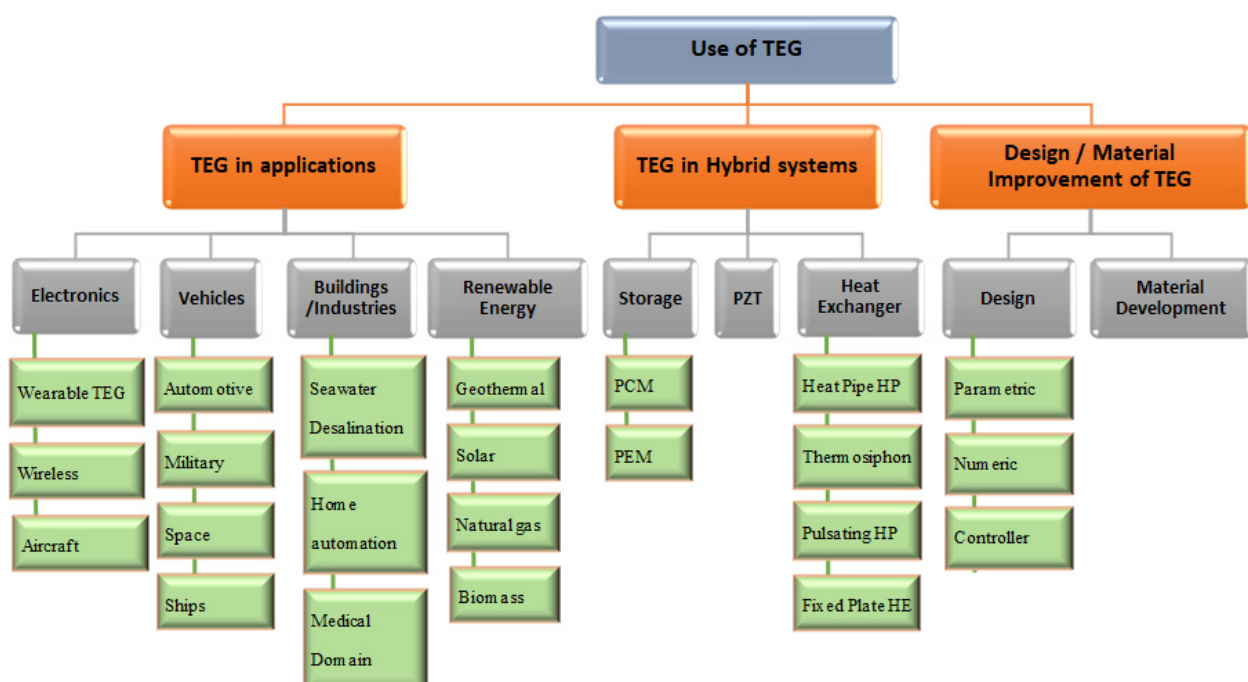

Figure 10. Classification of TEG usage.

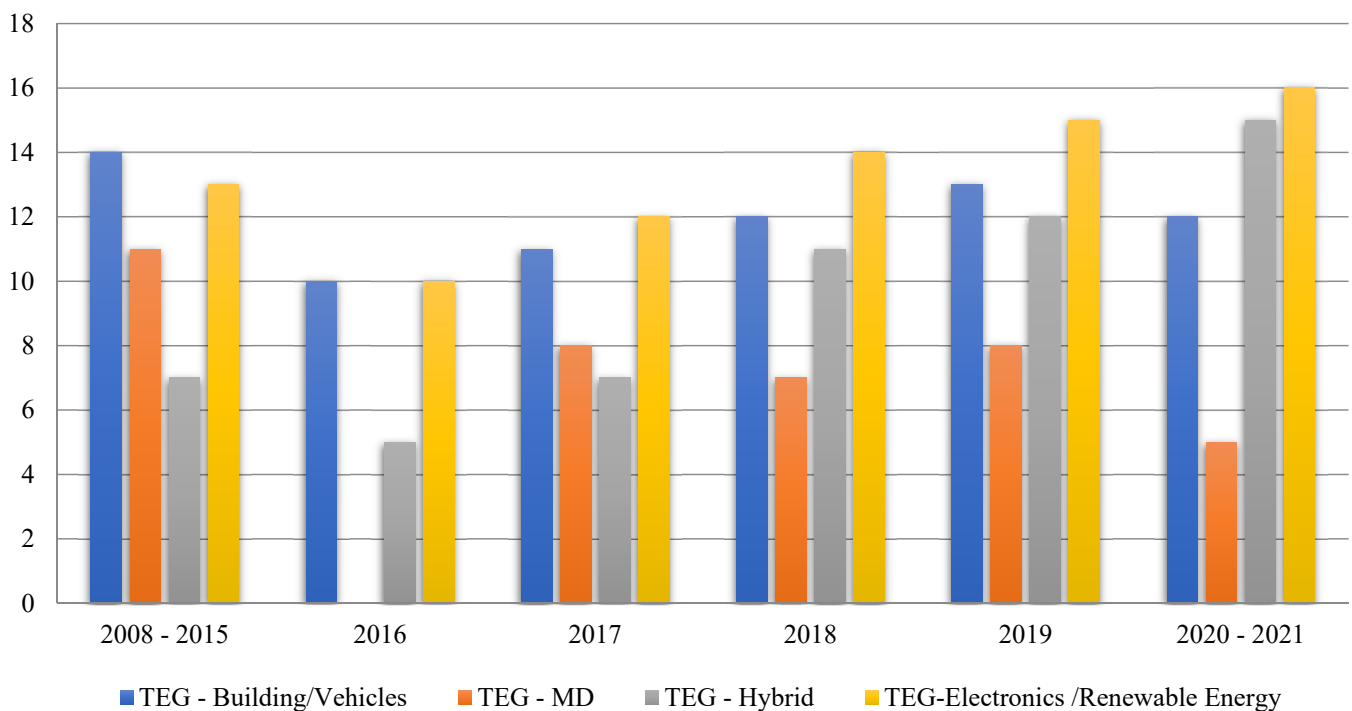

Figure 11. Investigated papers according to categories and years.

4.1. TEG in Heat Recovery Systems

As noticed from the results in the previous section, interest in energy has snowballed. This leads to the development of green technologies and creates a new sustainable energy resource. This widespread of TEG in various fields encourages investigating the impact of TEG on applications [89]. Table 3 shows the previous studies and applications of TEGs.

Table 3 shows the number of TEG in applications. The results of the most investigated cases agreed on the effectiveness and reliability of TEG, where the common conclusion was that TE is a promising technology. In addition, TEG has offered a remarkable effect when integrated into various fields. Table 2 shows that TEC cooling systems have benefits over conventional cooling devices, which is due to multicriteria that TEG owns, such as providing a new source of power from wasted thermal energy, small size, lightweight, no mechanical moving parts, high reliability, no working fluid, direct current power-driven, and swapping between heating and cooling modes easily.

Furthermore, it is noticed that some of the applications offer novel ideas with remarkable results. Other applications were not very practical [102,103], which could be attributed to various factors, such as the material of the TEG, design, and environment. Still, in both cases, however, the system offers or does not offer desirable results. Researchers are trying to improve the design and enhance TEG to enhance the growth of TEDs. Recently, researchers recommend integrating TEG with some heat recovery methods, such as heat exchangers, PCM, and HP, where the benefits that this hybrid heat recovery system may offer are worth further experimental studies. In addition, commercially developing this system may result in agreeable outcomes, as noticed in various researches [104]. Furthermore, it is noticed that HEs with TEG are highly recommended. This could be attributed to the fact that HEs transfer the heat to the TEG, which helps in creating better circumstances to higher gradient temperature, and consequently higher power output.

Table 3. Summary of the investigated papers related to TEG integrated into different applications.

Authors	Methodology	Results
Tabar et al., 2021 [90]	A non-conventional wasted energy recovery system is proposed. This novel framework contains a transformation of excess power, capturing energy loss, helps in reducing pollution and operational cost.	Results obtained assure the ability of the novel design to achieve an almost zero energy configuration, where the environmental pollution and total cost are cut by 170.7% and 83.5% per day, respectively.
Babu et al., 2017 [91]	Performance of various solar panel thermal hybrid systems was studied under different configuration such as design, location, TEG junction, additional parameters of design (active or passive cooling), and integration with phase change materials (PCM). Then, the best configurations and future expectation for the PV-TEG design system were presented.	The performance of the PV-TEG system is highly affected by the parameters of TEG results in additional energy that varies from 10% to 20% with overall efficiency that ranges between 40% and 50%. One of the optimum configurations was the hybrid system PV-TEG combined with PCM, which enhances the overall efficiency by 1 to 2%. TEG-PV shows a promising technology for the future; the progress in the TEG can affect significantly any μ grid networks.
Bayendang et al., 2020 [88]	A review of 18 diverse studies on TE and a polymer electrolyte membrane fuel cell (PEMFC) of a hybrid combined cooling heating and power (CCHP) system for domestic/commercial uses was held. To accomplish this, assorted studies on thermoelectricity were investigated. A comparison of TEG and solar energy analysis was held as well.	Results of these studies show that the power efficiency of TE augmented by transforming waste heat into power as for TEGs, and power into cold as for TECs. Furthermore, in TEC and PEMFC hybrid CCHP system, the prime mover was the PEMFC and TEC was the cooler, which was able of producing 2.79 kW of electricity, 26.8 W of cold, and 3.04 kW of heat, resulting in 43.3% of fuel saving and ~77% of total efficiency. The comparison study shows that TEG produces higher power in comparison to solar cells (SC) of equivalent sizes, although more expensive.
Darkwa et al., 2019 [86]	Theoretical, numerical, and experimental studies were held on a hybrid system model of TEG that generates limited output power due to small gradient temperature and PCM that has impact on the raise of temperature of the PV through the process of heat storage. The result of different PCM parameters conductivities, thicknesses, and phase change temperatures were calculated.	Simulation results proved the significance of high conductivity of PCM and thickness of PCM layer has impact on layers of TEG and PV. The optimum heat performance for the model PV/TEG/PCM was attained at a 50 mm PCM layer thickness with 5 W/mK thermal conductivity and a phase change temperature that ranges from 40 to 45 °C.
Sarveshwar et al., 2018 [92]	A wide investigation for summer and winter solar radiation on the thermodynamics assessment of an irretrievable CPV-TEG cogenerating system was held through different modules Siemens SP75 PV and Bi ₂ Te ₃ TE, which is commercially accessible. The hybrid system has been demonstrated and simulated to comprehend the viability of the system and to govern the irreversibility's existent in the hybrid system.	Results displayed that TEG has adversative impact on the hybrid system act and the irreversibility's rise with growth of concentration ratio, C. In addition, the output power of the hybrid system rises by 86% with the increase in C from 1 to 3 and the efficiency of exergy is greater than the energy efficiency by 8%. The greater values of the irreversibility's leads to a less inefficient system, thus, substantial developments are required since the higher temperature may lead to formation of hot spots.
Ghude et al., 2013 [93]	A study on alternative cooling methods is done, due to the high demand on HVAC and its hazardous effect, where the conventional HVAC system utilizes harmful cooling system that drains the ozone layer. So, the paper presents a comparison study between conventional HVAC and novel cooling system concept HVAC TEC.	Results show that in order to improve conventional HVAC to be ecofriendly requires a long time. Although refrigerant used is HFCs that have lower effect than CFCs over the ozone layer, yet it also affects negatively the ozone layer. On the other hand, HVAC (TEC) model proved superior advantages and better alternative.
Patyk 2013 [94]	A study on TEG for improving the efficiency of power generation in ICE and motor generators. Furthermore, a study of environmental and economical values of TEG was held.	Results reveal that TEG saves energy costs and has negligible environmental burden, (eco-efficient). However, it has low production compared to other methods.
Hiang et al., 2018 [95]	This paper presents the history and the achievement of TEG development in vehicles during a 7 year program on waste heat recovery incorporating TEG in a BMW X6 and a Lincoln MKT. Throughout this program, several models of TEG were demonstrated, and examined. A comparison analysis on the performance of the vehicle with and without TEG was then concluded.	Results showed that the generated power exceeded 700 W. The Department of Energy (DOE) program was successful, which results in leading a DOE-sponsor of TE WHR program for automotive that is concentrated on declaiming technical and business-related issues. This process is destined to permit TEGs to be more involved in the future automotive products and enhances this field.
Zheng et al., 2016 [96]	A simulation of TEG integrated in vehicle power system on ADVISOR software is being modeled by building a relation between the speed of engine and gradient temperature to study the possibility of the TEGs to enhance the fuel efficiency for both conventional vehicles and hybrid electric vehicles (HEVs). The simulations are held out on a conventional automobile and a hybrid TEG-based automobile power structure for 4 representative driving cycles and 6 electrical loads.	The consumption of fuel in both cases were compared and investigated to calculate the fuel economy. Results display that fuel economy was enhanced in both cases, a greater enhancement was noticed in conventional vehicle. Furthermore, an endeavor to integrate TEG more in vehicles is made and an effort is exerted to improve this technology to take bigger share in waste heat recovery fields.

Table 3. Cont.

Authors	Methodology	Results
Chen et al., 2020 [97]	Experimental and actual study on thermoelectric elevator car air conditioner (TE-ECAC) is held. The performance and cooling characteristics were examined experimentally in an Enthalpy Lab, and the performance of TE-ECAC was enhanced after the analysis. In addition, the weight of TE-ECAC was measured of 10 kg; however conventional air elevator was 38 kg at least.	Results show that ECAC can reach a steady working state at about 200 s. Highest capacity of air-cooling of 324 W and an optimum cooling coefficient of 1.24 can be attained at 1.75 m ³ /min of the cold side flow rate and 28 °C of ambient temperature. In addition, studies show that TE-ECAC has superior potentials than conventional; where TE-ECAC is much more economical with less weight.
Kishore et al., 2020 [98]	Experimental and numerical studies were established to prove the presence of a critical coefficient for heat transfer that drastically impacts the performance of TEGs. In addition, exterior thermal resistances and boundary conditions (BCs) have strong impact on the behavior of TE materials.	Results ensure that BCs effect substantially on the design of TE, where the performance of a TEG differs with the variation of the BCs. For low-grade WHR, the optimized TEG produced 28% greater power and compared to saleable modules optimized, TEG produce 162% greater power per unit mass of TE materials.
Shen et al., 2019 [99]	An intensive review on automotive exhaust thermoelectric generators (AETEGs) was held from various perspectives. The feasibility of AETEGs has been demonstrated and a considerable progress has been made. In addition, the review presents some challenges and recommendations that may direct the future work to a great extent such as integrating TEG with some other heat recovery methods and improving TE materials.	Integrating heat pipes (HP) in TEG would offer extra benefits to the system such as enhancing heat transfer to avoid the damage of TEG from high temperature. Integrating phase change materials (PCM) in TEG would offer extra benefits as well and it is worth to be developed and employed commercially, as it protects TEG from damage due to high temperature, uses depleted heat efficiently and decreases the pollutant emission and the fuel consumption.
Li et al., 2016 [100]	A simulation study under the same operational conditions on tube and fin heat exchangers (HE) using ANSYS is held. A number of factors were studied such as the variation of the temperature and the Reynolds number.	Both HEs show an agreeable thermal performance with TEG. The fin HE shows better thermal performance due to its compactness. In addition, it displays creation of vortex from the inlet of the pipes to the outlet. Consequently, this structure results in various increases in the temperature even at low Reynolds number.
Min et al., 2020 [101]	A mathematical model is established to design a TEG for recovering heat loss from exhaust of a diesel engine.	Results show that the efficiency of the TEG ranges between 1.41% to 4.12%, which is very low. Thus, further improvement should be held.

4.2. TEG in Hybrid Heat Recovery Systems

As noticed from Table 3 in the previous section, TEG integrated with other heat recovery methods shows desirable results. Thus, a deeper investigation on this section is held. The heat recovery methods discussed in the previous section lead to an increase in the power output: this could be attributed to the heat that the HEs recover, consequently increasing gradient temperature, which raises the power output.

TEG combined with other recovery methods was illustrated in various previous studies [105,106], where throughout the research, it is noticed that TEG with specific heat recovery methods that are shown in Figure 12 was investigated repeatedly.

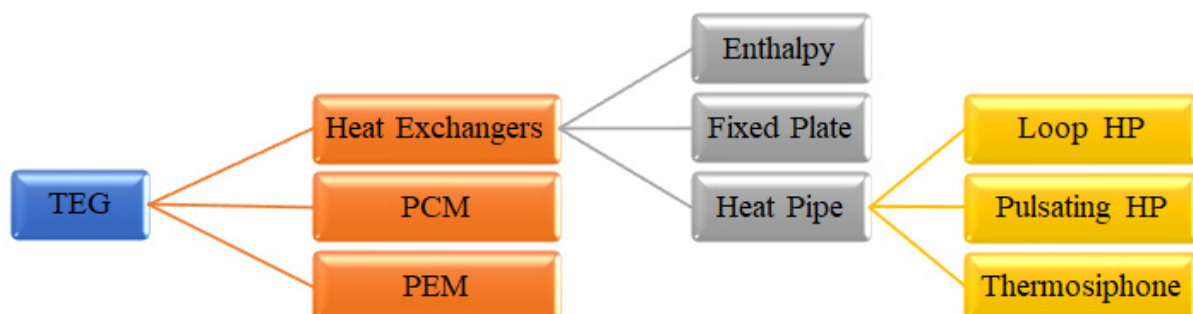

Figure 12. TEG integrated with heat recovery devices.

TEG integrated into HE is a widespread technology. For instance, Seo et al. [107] proved the effectiveness of TEG with HEs. In addition, Zaher et al. [108] showed that the power was increased by 1.2 in axial conduction HE at even low flow rates of around 0.02 kg/s. Moreover, Wang et al. [109] performed an experimental study on the TEG-

HE hybrid system to result in an efficiency of around 84%. Another study was done by Bélanger et al. [110] to investigate the performance of TEG sandwiched in a crossflow HE. Additionally, Catalan et al. [111] conducted a study on TEG integrated with thermosiphon HE to conclude that the power generated per module was 3.29 W with ΔT of 180 °C, and the design was 54% better with fin dissipaters. Araiz et al. [87] concluded that the hybrid TEG thermosiphon and PCM system is very effective and highly reliable in waste heat recovery applications.

Furthermore, Catalan et al. [112] held a study on TEG integrated with a PCM in a 5000 m² geothermal plant. The model was first studied as a computational model. The error between the experimental and computational models was less than 8%. Thus, based on the obtained model, a geothermal TEG (GTEG) system was performed as a computational study, where the GTEG system provided annual electric output of 681.5 MWh. Moreover, Tuoi et al. [113] conducted research that shows the significant potential of TEG integrated with PCM, especially with the rise of the new era of the Internet of Things (IoT). Such potential is illustrated more in research held [114] that studied a complete self-powered wireless sensor nodes (WSNs) system. This system consists of TEG and heat pipe heat exchanger and is considered to operate successfully. Furthermore, various researches illustrated the effectiveness of TEG combined with HEs [115–117]. Thus, it is recommended to do further studies on TEG in heat exchangers, as this system shows high reliability and agreement.

5. TEG New Technologies in Applications and Challenges

In this section, three prominent aspects will be studied: (1) Materials used in TEG that have a high impact on efficiency [118], since studying the material properties is crucial to the development of the system. (2) TEG new technologies, wherewith the increasing demand of the global for alternative energy sources, TEG technologies have shown a high share in the research work and has become a need in the modern world. (3) Challenges, wherewith all the benefits that TEG offer, it holds many challenges, such as low efficiency.

5.1. Materials Properties

While choosing TEG, several factors should be taken into consideration. Ideally, throughout the process, temperature grade across TEG is significant to the extent that the thermal expansion will create stress. Consequently, a fracture may occur inside the device, thus, the mechanical properties of the materials should be studied, and the thermal expansion coefficient of the P-and N-type material should be reasonably harmonized [119]. In addition, the optimum TEG should fulfill the requirement, such as electrically conductive as a single crystal, thermally non-conductive as glass. These characteristics are presented in phonon-glass electron-crystal (PGEC), which are high electrical conductivity (crystal), and small lattice thermal conductivity (glass). That is why the optimum TEG materials were defined as PGEC [120]. Thus, to obtain a reliable TEG, the characteristics of the materials used are likely to be reached, where the more close the materials get to the desirable properties presented in Table 4, the higher the efficiency of TEG will be attained [121]. For instance, semiconductors are much more efficient than metals, where heat is conveyed entirely by free electrons, whereas in a semiconductor's lattice, vibration is a surplus mechanism for transporting heat.

As can be seen from Table 4, efficient TEG requires materials with high electrical and low thermal conductivity, two contradictory features, where no material ideally has these two characteristics simultaneously. Semiconductors constitute a turning point in developing the TEDs [124], where the employment of TE was constrained before semiconductor materials were established [125]. Three semiconductors that are shown in Figure 13 are identified to have both low thermal conductivity and high electrical conductivity (presented by the high power factor) [126].

Table 4. Desirable properties of materials for an efficient TEG.

Material's Requirements	Physical Meaning	Effect on ZT	
High thermoelectric power (θ)	To generate maximum voltage in the circuit.		
Power factor	High Seebeck coefficient (α) [123] $\frac{\Delta V}{\Delta T} = \frac{V_A - V_B}{T_A - T_B}$	The power factor affects directly on ZT, the higher power factor, the higher ZT will be.	
	High electrical conductivity (σ)		To decrease losses due to temperature Joule heating.
	Low electrical resistivity (Ω)		
High ZT [122] $\frac{\alpha^2 \sigma T}{K_e + K_L}$			
Operating temperature	The operating or mean temperature.	T affects positively on ZT, which means higher T leads to higher ZT	
Low thermal conductivity (κ_e)	To minimize the transfer of heat from the hot side to the cold side, thus maintaining a large gradient temperature.	$(\kappa_L + \kappa_e)$ is inversely proportional to ZT, for instance, as $(\kappa_L + \kappa_e)$ increase ZT decreases	
Lower scatter phonons (κ_L) Lattice component	Accumulating phonon scattering decreases thermal conductivity consequently increases ZT.		

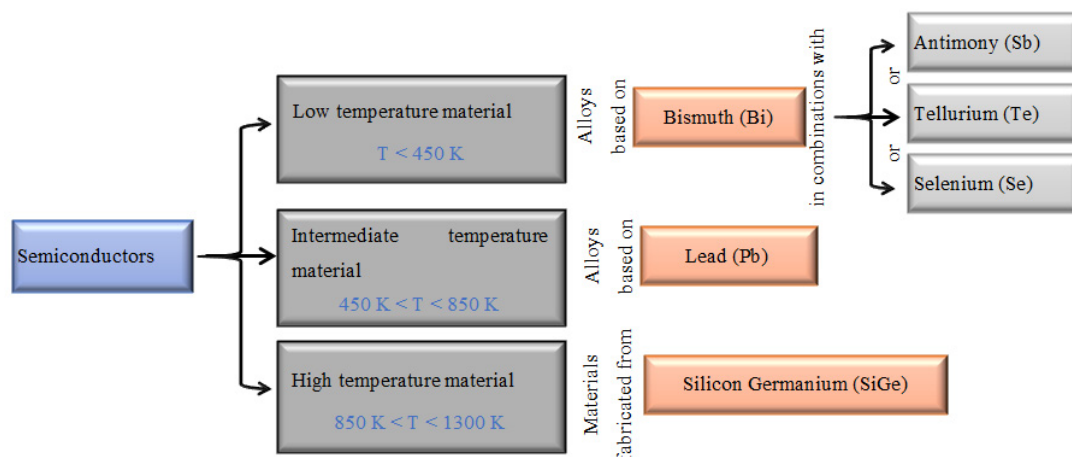

Figure 13. Presentation of the three semiconductors according to temperature endurance.

Recently, organic semiconductors (OSCs) were comprehensively studied in various fields [127]. OSCs possess a wide bandgap and weak intrinsic charge carrier density, which limited its widespread [128]; besides, N-type materials have more tendency to acquire high ZT than P-type materials. However, N- types have more limitations in terms of stability and availability, making P-type materials better than N-type materials. Fortunately, after excessive effort in research doping method was introduced on N-type materials to evolve higher ZT by developing air-stable and high-mobility N-type [129]. Montgomery et al. [130] presented a new spray doping technique that brings out a thin film carbon nanotube (CNT) polymer controllable TE properties. Electrical conductivity and Seebeck were tested and compared with a conventional system to show that the capability to adjust the length of these regions via the mask ultimately allows the developer to have higher control over device dimensions. Using this technique results in an active axis through the thickness of a low-profile and a high-density layered CNT-based TEG. The replacement of solution-based doping with spray doping has significant implications to the viability of the production of CNT TEGs, showing that with a proper design, organic TEG can be closer in performance to inorganic TEG than intrinsic ZT values.

Furthermore, Toan V et al. [131] conducted experimental research on achieving high-performance TEG through electrochemical disposition. The results show that the nickel-doped bismuth telluride is more than five times higher than that of the electrodeposited pure bismuth telluride under similar evaluation conditions. Moreover, the highly scalable thermoelectric material's synthesis has been proven, which could open the possibility toward the mass production for the low cost and high performance electrochemically deposited thermoelectric materials.

Although semiconductors are widely applied in commercial and practical applications, substantial developments have been set in finding or fabricating novel material structures with improved thermoelectric performance. Lately, there has been much research on harvesting higher energy from the TEG by dropping lattice thermal conductivity to improve ZT, which is done by working on the material. Research has gone so far in improving the materials, such as silicon-nanowire of high power TEG, nanotechnology [36], or nanostructures [132]. Over the recent period, a promising technology renowned as nano-inclusion, which is the formation of nano-composite, is proved to enhance the power factor electrical or thermal conductivity [133], where merging inorganic-organic nano-materials conquer the limitation of mono-phase TEG to attain higher ductile strength and manageable Seebeck coefficients in nanocomposite materials [134]. Furthermore, porous thermoelectric nanocomposites are a new effective method because of their excellent electrical conductivity and low thermal conductivity due to the phonon diffusion at the boundaries. These materials are lightweight, thus unlocking the opportunities to be used in portable devices, yet, achieving such materials requires much effort [135,136]. Subsequently, TEG is considered as a fundamental technique for waste energy, mainly on a low scale. Although the crucial profits of TEGs are their low maintenance and compactness, the cost of TEGs of the available materials is still too high.

High gradient temperature across TEG results in higher efficiency outcomes. However, this might damage the TEG. To overcome this problem, some researchers have offered to integrate distinct TE materials to construct what are called segmented TEGs [137]. Segmented TEGs are made up of two or more courses of TE materials sorted in series. This combination leads TEGs to function at a high thermal gradient, consequently expanding the power output and efficiency compared to the single TEGs under the same temperature difference [138]. Hu et al. [139] conducted a comparative study between a nanostructured PbTe-BiTe segmented TEG module and a single TEG that is just nanostructured PbTe based material. The results showed that at a temperature gradient of 590 K, segmented TEG had 11% efficiency, however single TEG had an efficiency of 8.8%.

Regardless of the favorable outcomes offered by segmented TEGs, they have not been extensively investigated due to inherent complexity in their design optimization and manufacturability. Segmentation introduces additional thermal and electrical interfaces between different TE layers, which increases contact resistances. The electrical contact resistance generates extra Joule heat, and the thermal resistance leads to abrupt temperature drop at the interface. Both these effects are undesired as they adversely affect the performance of TEGs.

In addition to studying the selection of the materials, it is concluded from the investigated papers that the performance of TEG depends on various factors other than materials used, as shown in Figure 14. These factors include achieving a high figure of merit (ZT), which is an essential factor that the scientists are working on increasing [140], durability that lasts for a significant duration with low maintenance, mass flow rate, and gradient temperature, which are affected by the design and application used, reliability that is affected by all the studied factors. All these factors are interrelated and affect each other. For example, material properties constitute one of the factors that affect ZT. Enhancing ZT has an impact on durability and reliability, and so on.

The design directly affects TEG and consists of many parts, such as the shape of TEG, size, the thickness of the material, and additive materials. For instance, Lei et al. [141] conducted a study of thick layer formation on bismuth telluride (Bi_2Te_3) and its effect.

The results show that for the growth of a 600-micron thick layer, the structure was more coherent, compact, uniform, and achieved good properties for TEG. On the other side, Yin Y. et al. [142] reported the impact of thickness on electrical conductivity, Seebeck coefficient, and power factor of $\text{Ca}_3\text{CO}_4\text{O}_2$ thin films formation on a single-crystal sapphire substrate. The results show that thinner films possess a higher Seebeck coefficient, however they lower electrical conductivity, thus a critical thickness that offers optimum result was found at the intermediate of the thicker and thinner films.

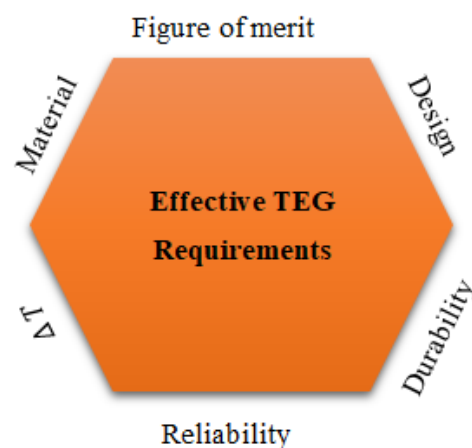

Figure 14. Requirements for effective TEG.

5.2. New Technologies and Applications

Over the years, TEG has proved that it is in continuous progress; far from conventional TEG, micro TEG was introduced due to the main advantage of TEG, which is generating power at small grade waste. M-TEG that functions at low gradient temperature has unlocked advanced applications in various areas, such as consumer electronics, the Internet of Things (IoT), and biomedical engineering. With the development of further low-power devices and the regular enhancement of figure-of-merit of TEG material, there are high expectations on the μ -TEG that will be useful in additional applications with remarkable effects [143]. In addition, TE modules are estimated to reach 10% to 20% efficiency with a hot side temperature limitation that exceeds 500 °C [144]. Accordingly, this is considered to be a great solution in the future to decrease the cost of power generation.

Theoretically, research succeeded in conducting thermal conductivity of the lattice. Scientists have effectively configured materials at the nanoscale level [145]. Consequently, TEG is considered a promising technology that will have a widespread positive effect on various applications. Figure 15 shows TEG use in applications for power generation and cooling starting 1980 till 2021, and the expectation of using TEG till 2030, where different researches expected the fields where TEG and TEC will be used [146,147].

There was no specific year for the starting date of some of the applications. The starting year was set based on revising the papers and the review papers related to applications of TEG, then finding the first time each application was mentioned.

As noticed from Figure 15, TEG and TEC for power generation and cooling are widespread over different applications, where it takes a significant share in various fields. For instance, one of the major sources of energy consumption, space cooling, foretold that the claim of TEC would amount to 80% by 2030 [158]. Likewise, the evolution of TEG guides to more challenges, such as bio-integrated systems [159], wearable electronics [160], micro thermoelectric generators [143], robotics [157], cybernetics, phonon glass electron crystal (PGEC) materials [161], military [18], and others [162]. Such challenges drive innovative engineering methodologies, where researchers are working on replacing the battery, which is the supreme dominant source of energy, in wearable devices by TEG. This is considered a successful step due to producing free energy and being environmentally friendly by reducing batteries' hazardous chemicals [163].

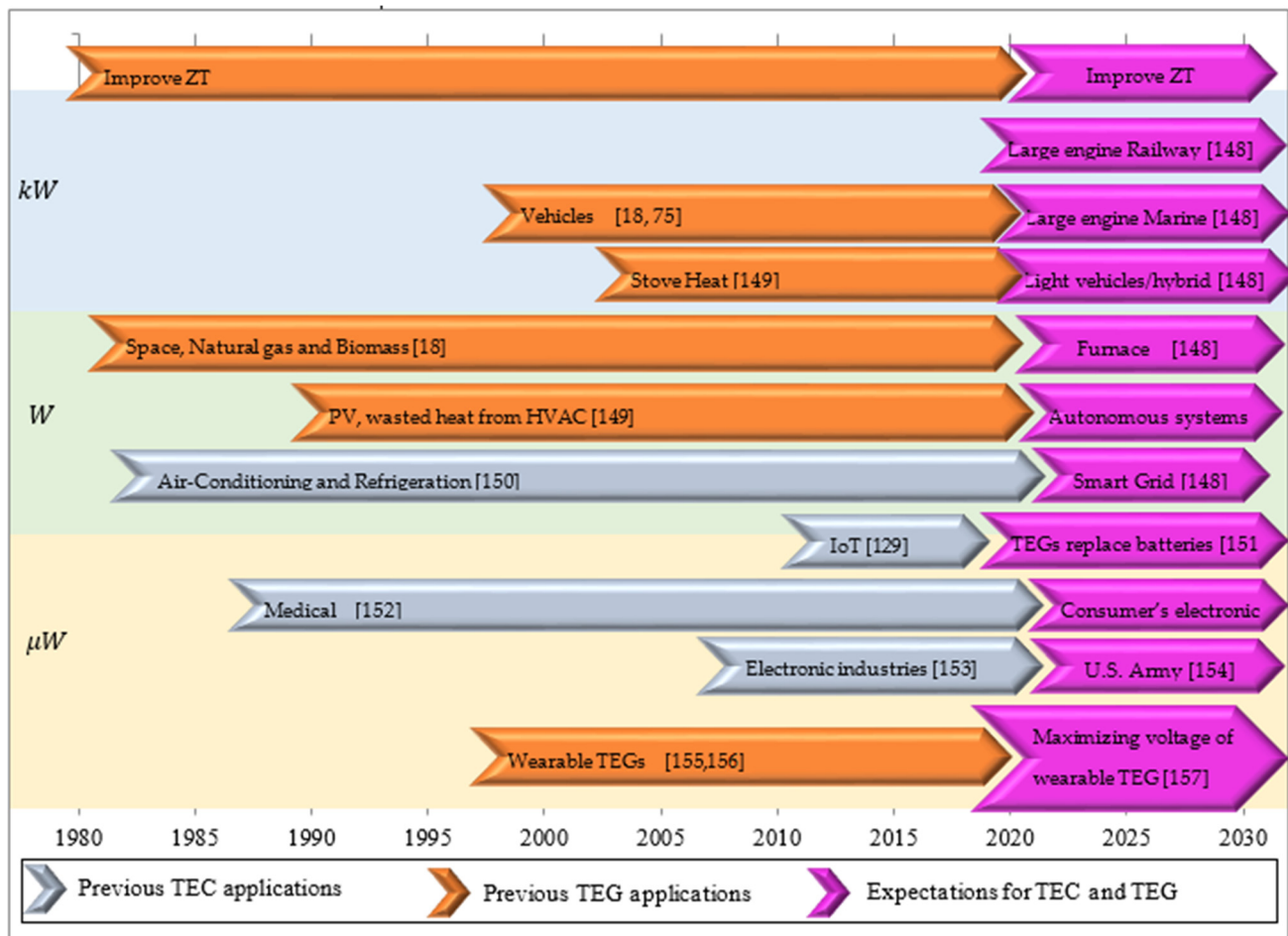

Figure 15. TEG and TEC in applications [148–157].

Figure 15 shows that after the mid-1990s, thermoelectricity has come with the flow of novel ideas. Furthermore, working on enhancing TEG is an ongoing process, which also continues for future expectations, where theoretical expectations recommended that TEG efficiency could be impressively improved due to the nanostructure engineering [152], besides the hope for designing a better TEG has always been a target that the scientists work on especially after the innovation of the nanometer scale. This ongoing TEG research has led to more significant improvement in TEG and being more involved in various applications.

5.3. Challenges

Throughout the research, several challenges have come across during the study of TEG. In this section, a review of the researchers' challenges while researching is presented in Table 5. Challenges are considered a vital sign that the research should try to solve to develop the material. Over the years, solving the challenges has led to growing TEGs even more and opening the opportunity to be involved in various applications. For instance, one of the main challenges of TEG is acquiring higher ZT, which is due to the intrinsic relation between thermal conductivity and electrical conductivity of most materials. An alternative approach to intensify ZT is by dropping the total thermal conductivity, which can be achieved through structuring materials at a nanoscale level. Another challenge is the high output resistance, which is considered a general problem besides the high cost and low efficiency of TEG. So, to reach a considerable output voltage, a significant Seebeck coefficient (high $V/^\circ C$) is required. In some commercial devices, this issue is resolved by setting fewer elements in series, more of them in parallel [119].

Furthermore, converting waste heat in manufacturing is a big challenge for TEGs, which can attain a percentage in the overall efficiency and drop the environmental foot-prints, even with TNG's low efficiency.

Table 5. Summary of the challenges during investigating TEG.

Authors	Title	Challenges
Chen et al., 2012 [164]	Nanostructured thermoelectric materials: Current research and future challenge	<ul style="list-style-type: none"> Reaching ZT values greater than 3 is hard to date. Dramatic improvements are required in the power factor, which is related to further drop in the thermal conductivity and rise in the electron conductivity. Decrease the thermal conductivity.
Davis 2018 [165]	A study on TEG materials, applications, and challenges	<ul style="list-style-type: none"> Equalize among the heat flow and maxime the gradient temperature. High cost with low efficiency, two main issues in TEGs. High output resistance and reverse heat characteristics.
Liu et al., 2015 [166]	Current progress and future challenges in thermoelectric power generation: From materials to devices	<p>For device-level development, challenges for metallization conventional TE such as Mg₂Si, PbTe, Bi₂Te₃, CoSb₃, and oxides were studied.</p> <ul style="list-style-type: none"> Achieving high figure of merit is not the only issue, where high ZT with low gradient temperature is not efficient. Reliable TEG contact is a challenge, where each application requires specific design. At least three criteria for good TEG are required: effectiveness, reliability, and efficiency.
Shen et al., 2019 [99]	Automotive exhaust thermoelectric generators: Current status, challenges and future prospects	<ul style="list-style-type: none"> Automotive exhaust thermoelectric generators (AETEGs) efficiency is enhanced through two criteria, (1) figure of merit of the materials ZT_m and (2) the mean or operating temperature. Thus, TE requires continuous development, so the challenge is to reach optimum temperature and highest ZT. Other challenges for obtaining better TEG include evolving materials that tolerate high temperature, improving the exhaust heat exchangers design, increasing the study of HP and PCMs in AETEGs.
Goel et al., 2020 [167]	Polymer Thermoelectric: Opportunities and Challenges	<p>Large gradient temperatures for TE applications, in polymers, are not favorable and thus low-ΔT and power system is required for polymer-based TE, which is suitable for several low-cost uses such as sensors These applications do not require high ZT yet they are sensitive to flexibility, cost, and simple in fabrication besides, they require a large voltage output. Consequently, this quest requires higher Seebeck coefficient.</p>
Aswa 2016 [168]	Key issues in development of thermoelectric power generators: High figure of merit materials and their highly conducting interfaces with metallic interconnects	<p>This review consists of researches that discussed the evolution of efficient TEGs. The correlating challenges in the discussed researches are classified into:</p> <ul style="list-style-type: none"> Creating higher ZT of TE that operates at various temperatures. Several researches have studied the materials affecting ZT, which is done by either (i) enhancing the power factor or (ii) decreasing the thermal conductivity. Building ohmic relation of P- and N-type metallic connection that has minimal resistance contact. Obviously, these studies are materials specific and, in some cases, very low contact resistances have been obtained using appropriate buffer layers. Then, further investigations are required for the future, especially for the materials that are ecofriendly, providing high ZT, low cost, and stability. Constructing TEGs with less thermal transmission among hot and cold sides. <p>It is counted on the industries that are sharing a part in the manufacturing of TEGs with the augmentation of scientific and engineering research in TE. The TEG in commercial applications is foreseen to be indispensable in the very near future.</p>
Shuai et al., 2017 [169]	Recent progress and future challenges on thermoelectric Zintl materials	<p>Practically, there are several challenges in fabricating any module.</p> <ul style="list-style-type: none"> Extra thermal and electrical resistance at the contact between TE materials and brazing materials is considered as a major challenge.
O'Dwyer et al., 2017 [170]	Scientific and Technical Challenges in Thermal Transport and Thermoelectric Materials and Devices	<ul style="list-style-type: none"> Seeking comparable P-type is a challenge, where the N-type Mg₃Sb₂-based materials have shown better results than the optimum available P-type materials. However, P-type Mg₃Sb₂ TE performance is relatively low. Hence, another P-type Zintl could be implemented, but this may lead to more challenges due to the complicated design of the device.

As noticed in Table 5, in addition to enhancing ZT, there is an accumulative effort to improve new materials by mounting the electrical power output, declining cost, and evolving an environmentally friendly system. Hence, research on improving or developing new thermoelectric materials has no end. In addition, it is noticed that displaying challenges is a beneficial procedure for the development of TEGs, where the continuous research in resolving the previous challenges and developing TEG to become more reliable and efficient. As a result, this development in TEG is opening novel ideas for employing TE materials efficiently.

5.4. Proposed Solution to Some of the Challenges

Designing a system with minimal thermal losses is a solution for balancing between maximum temperature difference and heat flow across the modules. This design could be illustrated by emerging another heat recovery device that captures the heat loss, such as reliable heat exchangers (heat pipes) or storage materials (PCMs), and that is why the efficiency of TEG integrated with HP or PCMs is higher than TEG alone, as concluded in the previous section. This hybrid design solves the materials' interface heat losses and protects the TEG from damage at high temperatures.

There are solutions for some challenges that create new challenges, such as forced convection [171] or vortex generators, which are solutions for low heat transfer; however, forced convection requires a new power source, and vortex generators increase the pressure drop.

Other challenges are avoiding high pressure drops between the cooling and heating sources, almost perfect thermal isolation, appropriate low resistance metal contacts of the cold side and hot side, improving the design of modules, etc. [53]. In addition, the challenges of experimental complication systems in microfabricated optical systems blocked various groups from being interested in such fields, consequently restricting experimental work development. Another major challenge is the lack of theoretical and simulation data of the multiscale phonon modeling of nanocomposites. Furthermore, the manufacturing of the device is still slow due to heat transfer concerns [172]. Thus, a more advanced scheme based on heat transfer to increase efficiency must be studied. The growth of TE materials requires continuous efforts by materials scientists, physicists, chemists, and theory scientists.

Another challenge is that TEG has unstable low output DC voltage around 10 to 300 mV. A step-up DC-DC power conditioning system is needed to regulate the output voltage to a fixed high value. Thus, a step-up or a self-powered DC-DC voltage promoter circuit is vital to adjust output voltage to a stable higher voltage [173]. For instance, DC-DC-based TEG for automotive applications was highly considered, where Sahu S. K. et al. [174] exhibit a DC-DC voltage booster circuit that contains an amplifier and oscillator to intensify the output voltage supplied by a TEG. The boosting efficiency of the designed circuit was 50%. In addition, the multilevel DC-DC conversion affects the efficiency, where Li M. et al. [175] held a case study on multilevel DC-DC conversion based on TEGs, then compared the suggested design with a conventional mono stage system. The conversion efficiency of the proposed was improved by up to 400%.

As a result of the previously studied papers, the advantages and disadvantages of TEG are summarized in Table 6. Some disadvantages can be reduced, such as the efficiency, which varies according to the materials used. Furthermore, even though the initial cost of the TEG is high, it is repaid after a long time, where the maintenance cost factor is null in these devices.

Table 6. Advantages and disadvantages of TEG.

	Advantages	Disadvantages
Design [176]	<ul style="list-style-type: none"> • High reliability • Durability • Scalability • No moving parts • Maintenance-free • Small in size and weight 	<ul style="list-style-type: none"> • Low efficiency • No standard scheme; every project is new • High initial cost • Difficulty of modeling TEG for simulation [177]
Operations	<ul style="list-style-type: none"> • Acoustically and electrically quiet • Mountable in all orientations 	<ul style="list-style-type: none"> • High output resistance
Materials	<ul style="list-style-type: none"> • Direct energy conversion, no intermediate form of energy conversion • No working fluids • Nontoxic materials [178] • Abundant raw materials [179,180] 	<ul style="list-style-type: none"> • Call for materials of both high thermal resistance and low thermal conductivity • Power generation efficiency of TEGs is affected by the material [181] • Expensive material • P and N possess diverse mechanical properties
Applications	<ul style="list-style-type: none"> • Vast range of power production (kW–μW) • Extreme climate conditions 	<ul style="list-style-type: none"> • High output resistance • Requires relatively constant heat source

6. Conclusions

This review has investigated the theoretical background of TEG, besides a comprehensive review of TEG and its implementation in various fields, as well as it sheds light on new technologies of TEG and the manifested challenges. Throughout the research, the following concluded outcomes are obtained:

- The distinctive nature of using TEG that provides electricity with a gradient temperature even at a low scale and over a wide temperature range, scalability, quietness, ecofriendliness, reliability, absence of moving parts, and maintenance-free, has made TEGs a primary solution to specific energy problems concerning power generation and recovering heat in a stationary and environmentally friendly approach;
- The small efficiency of TEG has limited its growth in some applications. The use of TE in several regions has conquered significant accomplishments in some applications and overall disappointment in others;
- TEG combined with HEs is an up-and-coming technology, where HEs transfer the heat to the TEG, which helps create better circumstances to higher gradient temperature and, consequently, higher power output, which was illustrated in various studies;
- For waste heat recovery applications, TEGs are very promising as well because the heat is free and lost unless it is captured by a heat recovery method. However, the payback period may be longer or shorter according to the gradient temperature and TEG efficiency. Consequently, the research is converged on enhancing the efficiency of TE materials and studying new strategies of TEGs that provide superior incorporation of energy conversion systems;
- To increase the power output, TEG should under either one or both of the steps: increase ZT or gradient temperature, as shown in Figure 16. In some cases, the temperature cannot exceed a specific range to protect the TEG material. Thus, results show that combining TEG with other heat recovery methods, such as heat pipes, PCM, and PEM has augmented the desirable output, where the combined system increases the power output and protects the TEG from overheating. Hence, it is recommended to do further studies on TEG combined with other heat recovery methods;
- Forced convection enhances heat transfer, and consequently increases gradient temperature. However, it requires additional power. Thus, vortex generators are recommended to enhance heat transfer. Intensive research on micro TEG opened the opportunity to improve TEG in wearable devices, sensors, power electronics, where there are accumulative efforts to make micro TEG a substitute for the traditional batteries;
- Throughout the research, there is an accumulative effort to develop new materials diminish cost, and build an eco-friendly system. Even though TEGs have a high initial cost, in the long term, TEGs may repay the initial cost and become a profit-free energy source;
- The efficiency of TEG has been developed over the years due to design and materials improvement. However, with all the improvements on TEGs materials, most of the papers recommended further researches to solve the foremost challenge in TE technology, which is enhancing and designing innovative TE materials with proper values of the figure of merit and power factor. Hence, research on improving or developing new thermoelectric materials has no end;
- Constructing a TEG with theoretical efficiency is an enormous progress that the research is working on, especially with the various concrete challenges. Thus, the growth of TE materials requires continuous efforts by material scientists, physicists, chemists, and theory scientists.

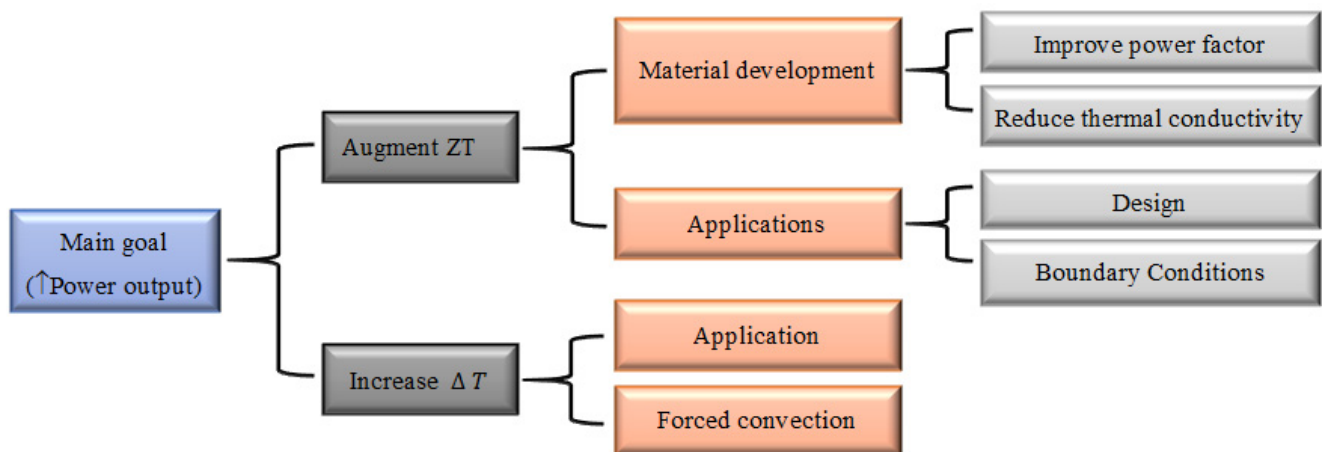

Figure 16. Schematic of how power output may be increased.

Author Contributions: Conceptualization, M.K.; methodology, R.A. and M.K.; validation, R.A.; formal analysis, R.A., J.F., S.A., T.L. and M.K.; investigation, R.A., J.F., S.A., T.L. and M.K.; data curation, R.A.; writing—original draft preparation, R.A.; writing—review and editing, J.F., S.A., T.L. and M.K.; supervision, M.K.; project administration, M.K. All authors have read and agreed to the published version of the manuscript.

Funding: This research received no external funding.

Institutional Review Board Statement: Not applicable.

Informed Consent Statement: Not applicable.

Data Availability Statement: Not applicable.

Conflicts of Interest: The authors declare no conflict of interest.

Nomenclature

BCs	Boundary conditions
CPV	Concentric photovoltaic
ERU	Energy recovering units
HHRS	Hybrid heat recovery system
HP	Heat pipe
HPHE	Heat pipe heat exchanger
HRS	Heat recovery system
PCM	Phase change material
PEM	Proton exchange membrane
PV	Photovoltaic
PZT	Piezoelectric
RES	Renewable energy system
TE	Thermoelectric
TEC	Thermoelectric cooler
TEG	Thermoelectric generator
TED	Thermoelectric device
THE	Thermosiphon
WHR	Waste heat recovery

References

1. Andreas, S.; Paula, F. Electricity: A New Open Access Journal. *Electricity* **2020**, *1*, 60–61.
2. Ciontea, C.; Iov, F. A Study of Load Imbalance Influence on Power Quality Assessment for Distribution Networks. *Electricity* **2021**, *2*, 77–90. [[CrossRef](#)]
3. Andrea, T.; Lidia, P.V.; Marco, B.; Giorgio, B. Assessing the Impact on Grid Infrastructure of Electrification Pathways for the Italian Residential Sector. *Electricity* **2021**, *2*, 48–62.

4. Ioannis, K.; Bazionis, P.; Georgilakis, S. Review of Deterministic and Probabilistic Wind Power Forecasting: Models, Methods, and Future Research. *Electricity* **2021**, *2*, 13–47.
5. Nikhil, K.; Jorrit, B.; Jose, R.T.; van der Meijden, M.; Palensky, P. A Fundamental Study on the Transient Stability of Power Systems with High Shares of Solar PV Plants. *Electricity* **2020**, *1*, 62–86.
6. Yildiz, F. Potential Ambient Energy-Harvesting Sources and Techniques. *J. Technol. Stud.* **2009**, *35*, 40–48. [[CrossRef](#)]
7. Khatun Mishu, M.; Rokonzaman, M.; Pasupuleti, J. Prospective Efficient Ambient Energy Harvesting Sources for IoT-Equipped Sensor Applications. *Electronics* **2020**, *9*, 1345. [[CrossRef](#)]
8. Gielen, D.; Boshell, F.; Saygin, D.; Bazilian, M.D.; Wagner, N.; Gorini, R. The role of renewable energy in the global energy transformation. *Energy Strategy Rev.* **2019**, *24*, 38–50. [[CrossRef](#)]
9. Mukhopadhyay, R.; Karisiddaiah, S.M.; Mukhopadhyay, J. Scientific Assessment. In *Climate Change: Alternate Governance Policy for South Asia*; Elsevier: Amsterdam, The Netherlands, 2018; pp. 15–53.
10. Mukhopadhyay, R.; Karisiddaiah, S.M.; Mukhopadhyay, J. Threat to Opportunity. In *Climate Change: Alternate Governance Policy for South Asia*; Elsevier: Amsterdam, The Netherlands, 2018; pp. 99–117.
11. Maradin, D. Advantages and Disadvantages of Renewable Energy Sources Utilization. *Int. J. Energy Econ. Policy* **2021**, *11*, 2146–4553. [[CrossRef](#)]
12. Juanicó, L.E. World Energy Saving from Cars: An Innovative and Feasible Proposal. *Int. Sch. Res. Not.* **2011**, *2011*, 5. [[CrossRef](#)]
13. Yu, M.G.; Nam, Y. Feasibility Assessment of Using Power Plant Waste Heat in Large Scale Horticulture Facility Energy Supply Systems. *Energies* **2016**, *9*, 112. [[CrossRef](#)]
14. Shareef, M.H.; Sajid, A.; Majeed, A.A.; Adnan, M.A.B. Efficiency Calculation of a Thermoelectric Generator. *Int. J. Sci. Res.* **2015**, *5*, 2319–7064.
15. Chen, J.; Li, K.; Liu, C.; Li, M.; Lv, Y.; Jia, L.; Jiang, S. Enhanced Efficiency of Thermoelectric Generator by Optimizing Mechanical and Electrical Structures. *Energies* **2017**, *10*, 1329. [[CrossRef](#)]
16. Snyder, J.; Eric, G.; Toberer, S. Complex Thermoelectric Materials. *Nat. Mater.* **2010**, *7*, 105–114. [[CrossRef](#)] [[PubMed](#)]
17. Karri, M.A. *Thermoelectric Power Generation System Optimization Studies*; Clarkson University: New York, NY, USA, 2011.
18. Zoui, M.A.; Bentouba, S.; Stocholm, J.G.; Bourouis, M. A Review on Thermoelectric Generators: Progress and Applications. *Energies* **2020**, *13*, 3606. [[CrossRef](#)]
19. Kumar, P.M.; Babu, V.J.; Subramanian, A.; Bandla, A.; Thakor, N.; Ramakrishna, S.; Wei, H. The Design of a Thermoelectric Generator and Its Medical Applications. *Designs* **2019**, *3*, 22. [[CrossRef](#)]
20. Indira, S.S.; Vaithilingam, C.A.; Chong, K.-K.; Saidur, R.; Faizal, M.; Abubakar, S.; Paiman, S. A review on various configurations of hybrid concentrator photovoltaic and thermoelectric generator system. *Sol. Energy* **2021**, *201*, 122–148. [[CrossRef](#)]
21. Patidar, S. Applications of Thermoelectric Energy: A review. *Int. J. Res. Appl. Sci. Eng. Technol.* **2018**, *6*, 2321–9653. [[CrossRef](#)]
22. Zimbovskaya, N.A. Seebeck effect in molecular junctions. *J. Phys. Condens. Matter* **2016**, *28*, 183002. [[CrossRef](#)]
23. Mukda, T.; Jantaratana, P. Peltier Effect Based Temperature Controlled System for Dielectric Spectroscopy. *J. Phys. Conf. Ser.* **2017**, *901*, 12059. [[CrossRef](#)]
24. Zhang, M.; Tian, Y.; Xie, H.; Wu, Z.; Wang, Y. Influence of Thomson effect on the thermoelectric generator. *Int. J. Heat Mass Transf.* **2019**, *137*, 1183–1190. [[CrossRef](#)]
25. Benziger, B.; Anu Nair, P.; Balakrishnan, P. Review Paper On Thermoelectric Air-Conditioner Using Peltier Modules. *Int. J. Mech. Eng.* **2015**, *4*, 49–56.
26. Igor Lashkevych, J.E.; Velázquez, O.Y.; Yuri, T.; Gurevich, G. Special Important Aspects of the Thomson Effect. *J. Electron. Mater.* **2018**, *47*, 3189–3192. [[CrossRef](#)]
27. Velmore, E. Thomas Johann Seebeck (1770–1831). *Proc. Est. Acad. Sci. Eng.* **2007**, *13*, 276–282.
28. Messler, R.W., Jr. Chapter 9: The Essence of Materials for Engineers. In *Assembly Automation*; Jones and Bartlett Learning: Burlington, MA, USA, 2011; pp. 243–274.
29. Bogala, M.R.; Reddy, R.G. Reaction kinetic studies of metal-doped magnesium silicides. *J. Mater. Sci.* **2017**, *52*, 11962–11976. [[CrossRef](#)]
30. Duckworth, H.E. *Electricity and Magnetism*; Holt Rinehart and Winston: New York, NY, USA, 1960; pp. 180–181.
31. Kinsella, C.E.; O’Shaughnessy, S.M.; Deasy, M.J.; Duffy, M.; Robinson, A.J. Battery Charging Considerations in Small Scale Electricity Generation from a Thermoelectric Module. *Appl. Energy* **2014**, *114*, 80–90. [[CrossRef](#)]
32. Mahan, G.D. Introduction to thermoelectrics. *APL Mater.* **2016**, *4*, 104806. [[CrossRef](#)]
33. Zhang, C.-W.; Xu, K.-J.; Li, L.-Y.; Yang, M.-Z.; Gao, H.-B.; Chen, S.-R. Study on a Battery Thermal Management System Based on a Thermoelectric Effect. *Energies* **2018**, *11*, 297.
34. Pasquale, G.D. Energy harvesters for powering wireless systems. In *Handbook of MemS for Wireless and Mobile Applications*; Woodhead Publishing Series in Electronic and Optical Materials: Torino, Italy, 2013; pp. 345–400.
35. Vaidya, M. Optimal Usage of Dissipated/Wasted Thermoelectric Energy (Including Human Heat) On a Small Scale through Harvesting. *Int. J. Innov. Res. Sci. Eng. Technol.* **2017**, *6*, 2347–6710.
36. Jouhara, H.; Żabnieńska-Góra, A.; Khordehghah, N.; Doraghi, Q.; Les Norman, L.A.; Axcell, B.; Wrobel, L.; Dai, S. Thermoelectric generator (TEG) technologies and applications. *Int. J.* **2021**, *9*, 100063.
37. Al-Habahbeh, O.M.; Mohammad, A.; Al-khalidi, A.; Khanfer, M.; Obeid, M. Design optimization of a large-scale thermoelectric generator. *J. King Saud Univ. Eng. Sci.* **2018**, *30*, 177–182. [[CrossRef](#)]

38. Champier, D. Thermoelectric generators: A review of applications. *Energy Convers. Manag.* **2017**, *140*, 167–181. [CrossRef]
39. Tzounis, L. *Organic Thermoelectrics and Thermoelectric Generators*; IntechOpen: London, UK, 2019.
40. Tritt, T.M. *Thermoelectric Materials: Principles, Structure, Properties, and Applications*; Elsevier: Amsterdam, The Netherlands, 2002.
41. Kuphaldt, T.R. Electrons and “holes”. In *Semiconductors: Solid-State Device Theory*; Prentice-Hall: Hoboken, NJ, USA, 2001.
42. Prunet, G.; Pawula, F.; Fleury, G.; Cloutet, E.; Robinson, A.J.; Hadziioannou, G.; Pakdel, A. A Review on Conductive Polymers and Their Hybrids for Flexible and Wearable Thermoelectric Applications. *Mater. Today Phys.* **2021**, *18*, 100402. [CrossRef]
43. Zhu, W.; Deng, Y.; Gao, M.; Wang, Y.; Cui, J.; Gao, H. Thin-film solar thermoelectric generator with enhanced power output: Integrated optimization design to obtain directional heat flow. *Energy* **2015**, *89*, 106–117. [CrossRef]
44. Kanimba, E.; Tian, Z. Modeling of a Thermoelectric Generator Device: A Look at Trends in the Technology. In *Thermoelectrics for Power Generation—A Look at Trends in the Technology*; IntechOpen: London, UK, 2016; pp. 461–479.
45. Meng, F.; Chen, L.; Sun, F. Performance analysis for two-stage TEC system driven by two-stage TEG obeying Newton’s heat transfer law. *Math. Comput. Model.* **2010**, *52*, 586–595. [CrossRef]
46. Salim, A.T.A.; Prasety, Y.; Fakhrudin, Y.A. Study of Effect Comparison Thermoelectric Characteristics of TEC and TEG by Considering the Difference in Temperature and Variable Resistant. *Int. Res. J. Adv. Eng. Sci.* **2018**, *3*, 2455–9024.
47. Srinivasan, B. Novel Chalcogenide Based Glasses, Ceramics & Polycrystalline Materials for Thermoelectric Application. Ph.D. Thesis, University of Rennes 1, Rennes, France, 2018.
48. Luo, X.; Bob, C.; Chong-an Di, S.; Mei, J. Flexible and Printed Organic Thermoelectrics: Opportunities and Challenges. Available online: <https://www.sigmaaldrich.com/FR/fr/technical-documents/technical-article/materials-science-and-engineering/organic-electronics/flexible-and-printed-organic-thermoelectrics> (accessed on 20 June 2021).
49. Twaha, S.; Zhu, J.; Yan, Y.; Li, B. A comprehensive review of thermoelectric technology: Materials, applications, modelling and performance improvement. *Renew. Sustain. Energy Rev.* **2016**, *65*, 698–726. [CrossRef]
50. Twaha, S.; Zhu, J.; Maraaba, L.; Huang, K.; Li, B.; Yan, Y. Maximum Power Point Tracking Control of a Thermoelectric Generation System Using the Extremum Seeking Control Method. *Energies* **2017**, *10*, 2016. [CrossRef]
51. Allon, I.H.; Chen, R.; Delgado, R.D.; Liang, W.; Erik, C.G.; Najarian, M.; Majumdar, A.; Yang, P. Enhanced Thermoelectric Performance of Rough Silicon Nanowires. *Nature* **2007**, *451*, 163–167.
52. Polozine, A.; Sirotinskaya, S.; Schaeffer, L. History of Development of Thermoelectric Materials for Electric Power Generation and Criteria of their Quality. *Mater. Res.* **2014**, *17*, 1260–1267. [CrossRef]
53. Zhang, X.; Zhao, L. Thermoelectric materials: Energy conversion between heat and electricity. *J. Mater.* **2015**, *1*, 92–105. [CrossRef]
54. Adhikari, K.R. Thermocouple: Facts and Theories. *Himal. Phys.* **2017**, *6*, 10–14. [CrossRef]
55. Goldsmid, H.J.; Sc, B.; Douglas, R.W. The use of semiconductors in thermoelectric refrigeration. *Br. J. Appl. Phys.* **1954**, *5*, 386–390. [CrossRef]
56. Punith, N.; Swamy, G.M.; Yalagi, S. A Thermoelectric Generator Systems Forwaste Heat Recovery—A Review. *Int. J. Eng. Res. Technol.* **2015**, *3*, 1–10.
57. Beretta, D.; Neophytou, N.; James, H.M.; Kanatzidis, M.G. Thermoelectrics: From history, a window to the future. *Mater. Sci. Eng. R* **2018**, *138*, 210–255. [CrossRef]
58. Uemura, K.-i. History of Thermoelectricity Development in Japan. *J. Thermoelectr.* **2002**, *3*, 1–16.
59. Zhang, Y.; Jaques, B.; Agarwal, V. *Final Technical Report on Nanostructured Bulk Thermoelectric Generator for Efficient Power Harvesting for Self-Powered Sensor Network, Notre Dame*; University of Notre Dame: Notre Dame, IN, USA, 2018.
60. Forman, C.; Muritala, I.K.; Pardemann, R.; Meyer, B. Estimating the global waste heat potential. *Renew. Sustain. Energy Rev.* **2016**, *57*, 1568–1579. [CrossRef]
61. Hendricks, T.; Choate, W.T. *Engineering Scoping Study of Thermoelectric Generator Systems for Industrial Waste Heat Recovery*; US Department of Energy Industrial Technologies Program: Washington, DC, USA, 2006; pp. 1–58.
62. Glatz, W.; Muntwyler, S.; Hierold, C. Optimization and fabrication of thick flexible polymer based micro thermoelectric generator. *Sens. Actuators A Phys.* **2006**, *132*, 337–345. [CrossRef]
63. Gou, X.; Xiao, H.; Yang, S. Modeling, experimental study and optimization on low-temperature waste heat thermoelectric generator system. *Appl. Energy* **2010**, *87*, 3131–3136. [CrossRef]
64. Crane, D.T.; Jackson, G. Optimization of cross flow heat exchangers for thermoelectric waste heat recovery. *Energy Convers. Manag.* **2004**, *45*, 1565–1582. [CrossRef]
65. Jaziri, N.; Boughamoura, A.; Müller, J.; Mezghani, B.; Tounsi, F.; Ismail, M. A comprehensive review of Thermoelectric Generators: Technologies and common applications. *Energy Rep.* **2020**, *6*, 264–287. [CrossRef]
66. Shi, Y.; Wang, Y.; Deng, Y.; Gao, H.; Lin, Z.; Zhu, W.; Ye, H. A novel self-powered wireless temperature sensor based on thermoelectric generators. *Energy Convers. Manag.* **2014**, *80*, 110–116. [CrossRef]
67. Patil, D.; Arakerimath, R.R.; Walke, P.V. Thermoelectric materials and heat exchangers for power generation—A review. *Renew. Sustain. Energy Rev.* **2018**, *95*, 1–22. [CrossRef]
68. Chen, A.; Wright, P.K. Medical Applications of Thermoelectrics. In *Modules, Systems, and Applications in Thermoelectrics*; CRC Press: Boca Raton, FL, USA, 2012; pp. 1–17.
69. Pennelli, G. Review of nanostructured devices for thermoelectric applications. *Beilstein, J. Nanotechnol.* **2014**, *5*, 1268–1284. [CrossRef]

70. Blanc, S.L. Thermoelectric generators: Linking material properties and systems engineering for waste heat recovery applications. *Sustain. Mater. Technol.* **2014**, *1*, 26–35.
71. Chen, T.; Zheng, Z.; Liang, G.; Fan, P. A New Design of a Thin-Film Thermoelectric Device. *Nanomaterials* **2020**, *10*, 990. [[CrossRef](#)]
72. Korotkov, A.S.; Loboda, V.; Dzyubanenko, S.V.; Bakulin, E.M. Design of a Thin-Film Thermoelectric Generator for Low-Power Applications. *Russ. Microelectron.* **2019**, *48*, 326–334. [[CrossRef](#)]
73. Chen, X.; Zhou, Z.; Lin, Y.-H.; Nan, C. Thermoelectric thin films: Promising strategies and related mechanism on boosting energy conversion performance. *J. Mater.* **2020**, *6*, 494–512. [[CrossRef](#)]
74. Karthikeyan, V.; Surjadi, J.U.; Wong, J.C.; Kannan, V.; Lam, K.-H.; Chen, X.; Lu, Y.; Roy, V.A. Wearable and flexible thin film thermoelectric module for multi-scale energy harvesting. *J. Power Sources* **2020**, *455*, 227983. [[CrossRef](#)]
75. Crane, D.; LaGrandeur, J.; Jovovic, V.; Ranalli, M.; Adldinger, M.; Poliquin, E.; Dean, J.; Kossakovski, D.; Mazar, B.; Maranville, C. TEG On-Vehicle Performance and Model Validation and What It Means for Further TEG Development. *J. Electron. Mater.* **2012**, *42*, 1582–1591. [[CrossRef](#)]
76. Wang, X.; Henshaw, P.; Ting, D.S.-K. Chapter 7—The Effect of Couple Layout on Thermoelectric Generator Performance. In *Climate Change Science*; Ting, D.S.-K., Stagner, J.A., Eds.; Elsevier: Amsterdam, The Netherlands, 2021; pp. 125–142.
77. Albatati, F.; Attar, A. Analytical and Experimental Study of Thermoelectric Generator. *Energies* **2021**, *14*, 204. [[CrossRef](#)]
78. Aridi, R.; Faraj, J.; Ali, S.; El-Rab, M.G.; Lemenand, T.; Khaled, M. Energy recovery in air conditioning systems: Comprehensive review, classification, critical analysis, and potential recommendations. *Energies* **2021**, in press.
79. Junior, O.H.A.; Maran, A.L.O.; Henao, N.C. A review of the development and applications of thermoelectric microgenerators for energy harvesting. *Renew. Sustain. Energy Rev.* **2018**, *91*, 376–393. [[CrossRef](#)]
80. Singh, M.; Nirapure, S.; Mishra, A. Thermoelectric Generator: A Review. *IOSR J. Mech. Civ. Eng.* **2015**, *12*, 40–45.
81. Ofoegbu, C.; Mazumder, S. Computational Modeling of a Solar Thermoelectric Generator. *J. Therm. Sci. Eng. Appl.* **2015**, *7*, 041004. [[CrossRef](#)]
82. Chahine, K.; Ramadan, M.; Merhi, Z.; Jaber, H.; Khaled, M. Parametric analysis of temperature gradient across thermoelectric power generators. *J. Electr. Syst.* **2016**, *12*, 623–632.
83. Ramadan, M.; Ali, S.; Bazzi, H.; Khaled, M. New hybrid system combining TEG, condenser hot air and exhaust New hybrid system combining TEG, condenser hot air and exhaust. *Case Stud. Therm. Eng.* **2017**, *10*, 154–160. [[CrossRef](#)]
84. Huen, P.; Daoud, W.A. Advances in hybrid solar photovoltaic and thermoelectric generators. *Renew. Sustain. Energy Rev.* **2017**, *72*, 1295–1302. [[CrossRef](#)]
85. Rinalde, G.F.; Juanicó, L.E.; Tagliavore, E.; Gortaria, S.; Molina, M.G. Development of thermoelectric generators for electrification of isolated rural homes. *Int. J. Hydrogen Energy* **2010**, *35*, 5818–5822. [[CrossRef](#)]
86. Darkwa, J.; Calautit, J.; Du, D.; Kokogianakis, G. A numerical and experimental analysis of an integrated TEG-PCM power enhancement system for photovoltaic cells. *Appl. Energy* **2019**, *248*, 688–701. [[CrossRef](#)]
87. Araiz, M.; Martínez, A.; Astrain, D.; Aranguren, P. Experimental and computational study on thermoelectric generators using thermosyphons with phase change as heat exchangers. *Energy Convers. Manag.* **2017**, *137*, 155–164. [[CrossRef](#)]
88. Bayendang, N.P.; Kahn, M.T.; Balyan, V. A Structural Review of Thermoelectricity for Fuel Cell CCHP Applications. *J. Energy* **2020**, *2020*, 2760140. [[CrossRef](#)]
89. Ruzaim, I.A.; Shafie, S.; Hassan, W.Z.W.; Azis, N.; Ya'aco, M.E.; Elianddyd, E.; Aimrun, W. Performance analysis of thermoelectric generator implemented on non-uniform heat distribution of photovoltaic module. *Energy Rep.* **2021**, *7*, 2379–2387.
90. Tabar, V.S.; Hagh, M.T.; Jirdehi, M.A. Achieving a nearly zero energy structure by a novel framework including energy recovery and conversion, carbon capture and demand response. *Energy Build.* **2021**, *230*, 110563. [[CrossRef](#)]
91. Babu, C.; Ponnambalam, P. The role of thermoelectric generators in the hybrid PV/T systems: A review. *Energy Convers. Manag.* **2017**, *151*, 368–385. [[CrossRef](#)]
92. Singh, S.; Ibeagwu, O.I.; Lamba, R. Thermodynamic evaluation of irreversibility and optimum performance of a concentrated PV-TEG cogenerated hybrid system. *Sol. Energy* **2018**, *170*, 896–905. [[CrossRef](#)]
93. Ghude, A.A.; Belokar, N.V.; Agrawal, R.O. Heating Ventilating and Air-Conditioning (HVAC) System Using Thermoelectric Couple (TEC). *Int. J. Eng. Res. Technol.* **2013**, *2*, 1–4.
94. Patyk, A. Thermoelectric generators for efficiency improvement of power generation. *Appl. Energy* **2013**, *102*, 1448–1457. [[CrossRef](#)]
95. Huang, K.; Yan, Y.; Li, B.; Li, Y.; Li, K.; Li, J. A Novel Design of Thermoelectric Generator for Automotive Waste Heat Recovery. *Automot. Innov.* **2018**, *1*, 54–61. [[CrossRef](#)]
96. Zheng, S.; Fan, W. Simulations of TEG-Based Vehicle Power System's Impact on the Fuel Economy of Hybrid and Conventional Vehicles. *SAE Tech. Pap.* **2016**, *1*. [[CrossRef](#)]
97. Chen, C.; Mao, L.; Lin, T.; Tu, T.; Zhu, L.; Wang, C. Performance testing and optimization of a thermoelectric elevator car air conditioner. *Case Stud. Therm. Eng.* **2020**, *19*, 100616. [[CrossRef](#)]
98. Kishore, R.A.; Nozariasbmarz, A.; Poudel, B.; Priya, S. High-Performance Thermoelectric Generators for Field Deployments. *ACS Appl. Mater. Interfaces* **2020**, *12*, 10389–10401. [[CrossRef](#)] [[PubMed](#)]
99. Shen, Z.; Tian, L.; Liu, X. Automotive exhaust thermoelectric generators: Current status, challenges and future prospects. *Energy Convers. Manag.* **2019**, *195*, 1138–1173. [[CrossRef](#)]

100. Li, W.; Paula, M.C.; Siviter, J.; Montecucco, A.; Knox, A.R.; Sweet, T.; Min, G.; Baig, H.; Mallick, T.K.; Han, G.; et al. Thermal performance of two heat exchangers for thermoelectric generators. *Case Stud. Therm. Eng.* **2016**, *8*, 164–175. [[CrossRef](#)]
101. He, M.; Wang, E.; Zhang, Y.; Zhang, W.; Zhang, F.; Zhao, C. Performance analysis of a multilayer thermoelectric generator for exhaust heat recovery of a heavy-duty diesel engine. *Appl. Energy* **2020**, *274*, 115298. [[CrossRef](#)]
102. Goupil, C. *Continuum Theory and Modeling of Thermoelectric Elements*; Wiley Network: Caen, France, 2016.
103. O'Halloran, S.; Rodrigues, M. *Power and Efficiency Measurement in a Thermoelectric Generator*; American Society for Engineering Education: Portland, OR, USA, 2012.
104. Atalay, T.; Köysal, Y.; Özdemir, A.E.; Özbaş, E. Evaluation of energy efficiency of thermoelectric generator with two-phase thermo-syphon heat pipes and nano-particle fluids. *Int. J. Precis. Eng. Manuf. Green Technol.* **2018**, *5*, 5–12. [[CrossRef](#)]
105. Lu, X.; Fei, X.; Zuoming, Y.; Qiuwang, Q.; Ma, W. Experimental investigation on thermoelectric generator with non-uniform hot-side heat exchanger for waste heat recovery. *Energy Convers. Manag.* **2017**, *150*, 403–414. [[CrossRef](#)]
106. Kashid, D.T.; Barhatte, S.H.; Ghodake, D.S. Heat Exchanger for Thermoelectric Power Generation Using Exhaust Waste-Heat Energy. *Int. Eng. Res. J.* **2015**, *4*, 138–145.
107. Seo, J.-H.; Garud, K.S.; Lee, M.-Y. Grey relational based Taguchi analysis on thermal and electrical performances of thermoelectric generator system with inclined fins hot heat exchanger. *Appl. Therm. Eng.* **2021**, *184*, 116279. [[CrossRef](#)]
108. Zaher, M.H.; Abdelsalam, M.Y.; Cotton, J.S. Study of the effects of axial conduction on the performance of thermoelectric generators integrated in a heat exchanger for waste heat recovery applications. *Appl. Energy* **2020**, *261*, 114434. [[CrossRef](#)]
109. Wang, T.; Luan, W.; Wang, W.; Tu, S.-T. Waste heat recovery through plate heat exchanger based thermoelectric generator system. *Appl. Energy* **2014**, *136*, 860–865. [[CrossRef](#)]
110. Bélanger, S.; Gosselin, L. Thermoelectric generator sandwiched in a crossflow heat exchanger with optimal connectivity between modules. *Energy Convers. Manag.* **2011**, *52*, 2911–2918. [[CrossRef](#)]
111. Catalan, L.; Aranguren, P.; Araiz, M.; Pérez-Artieda, G.; Astrain, D. New opportunities for electricity generation in shallow hot dry rock fields: A study of thermoelectric generators with different heat exchangers. *Energy Convers. Manag.* **2019**, *200*, 112061. [[CrossRef](#)]
112. Catalan, L.; Araiz, M.; Aranguren, P.; Astrain, D. Computational study of geothermal thermoelectric generators with phase change heat exchangers. *Energy Convers. Manag.* **2020**, *221*, 113120. [[CrossRef](#)]
113. Tuoi, T.T.K.; Van Toan, N.; Ono, T. Theoretical and experimental investigation of a thermoelectric generator (TEG) integrated with a phase change material (PCM) for harvesting energy from ambient temperature changes. *Energy Rep.* **2020**, *6*, 2022–2029. [[CrossRef](#)]
114. Kim, Y.J.; Gu, H.M.; Kim, C.S.; Choi, H.; Lee, G.; Kim, S.; Yi, K.K.; Lee, S.G.; Cho, B.J. High-performance self-powered wireless sensor node driven by a flexible thermoelectric generator. *Energy* **2018**, *162*, 526–533. [[CrossRef](#)]
115. Lee, W.; Lee, J. Development of a compact thermoelectric generator consisting of printed circuit heat exchangers. *Energy Convers. Manag.* **2018**, *171*, 1302–1310. [[CrossRef](#)]
116. Lv, S.; He, W.; Jiang, Q.; Hu, Z.; Liu, X.; Chen, H.; Liu, M. Study of different heat exchange technologies influence on the performance of thermoelectric generators. *Energy Convers. Manag.* **2018**, *156*, 167–177. [[CrossRef](#)]
117. Sheikh, R.; Gholampour, S.; Fallahsohi, H.; Goodarzi, M.; Taheri, M.M.; Bagheri, M. Improving the efficiency of an exhaust thermoelectric generator based on changes in the baffle distribution of the heat exchanger. *J. Therm. Anal. Calorim.* **2020**, *143*, 523–533. [[CrossRef](#)]
118. Montecucco, A.; Siviter, J.; Knox, A.R. The effect of temperature mismatch on thermoelectric generators electrically connected in series and parallel. *Appl. Energy* **2014**, *123*, 47–54. [[CrossRef](#)]
119. Davis, S. Chapter 10: Silicon Power Management Power Semiconductors. In *Power Management*; Prentice-Hall: Hoboken, NJ, USA, 2018.
120. Alam, H.; Ramakrishna, S. A review on the enhancement of figure of merit from bulk to nano-thermoelectric materials. *Nano Energy* **2013**, *2*, 190–212. [[CrossRef](#)]
121. Chasmar, R.P.; Stratton, R. The Thermoelectric Figure of Merit and its Relation to Thermoelectric Generators. *J. Electron. Control* **1959**, *7*, 52–72. [[CrossRef](#)]
122. Fu, C.; Wu, H.; Liu, Y.; He, J.; Zhao, X.; Zhu, T. Enhancing the Figure of Merit of Heavy-Band Thermoelectric Materials Through Hierarchical Phonon Scattering. *Adv. Sci.* **2016**, *3*, 1600035. [[CrossRef](#)]
123. Bubnova, O.; Berggren, M.; Crispin, X. Tuning the Thermoelectric Properties of Conducting Polymers in an Electrochemical Transistor. *J. Am. Chem. Soc.* **2012**, *134*, 16456–16459. [[CrossRef](#)]
124. Pei, J.; Cai, B.; Zhuang, H.; Li, J. Bi₂Te₃-based applied thermoelectric materials: Research advances and new challenges. *Natl. Sci. Rev.* **2020**, *7*, 1856–1858. [[CrossRef](#)]
125. Wael, A.; Salah, M.A. Review of Thermoelectric Cooling Devices Recent Applications. *J. Eng. Sci. Technol.* **2020**, *15*, 455–476.
126. Johansson, M.T.; Söderström, M. Electricity generation from low-temperature industrial excess heat—an opportunity for the steel industry. *Energy Effic.* **2013**, *7*, 203–215. [[CrossRef](#)]
127. Qiu, L.; Liu, J.; Alessandri, R.; Qiu, X.; Koopmans, M.; Havenith, R.W.A.; Marrink, S.; Chiechi, R.C.; Koster, L.J.A.; Hummelen, J.C. Enhancing doping efficiency by improving host-dopant miscibility for fullerene-based n-type thermoelectrics. *J. Mater. Chem. A* **2017**, *5*, 21234–21241. [[CrossRef](#)]
128. Zuo, G. *Doping and Density of States Engineering for Organic*; Linköping University: Linköping, Sweden, 2018.

129. Liu, J.; Garman, M.P.; Dong, J.; Van Der Zee, B.; Qiu, L.; Portale, G.; Hummelen, J.C.; Koster, L.J.A. Doping Engineering Enables Highly Conductive and Thermally Stable n-Type Organic Thermoelectrics with High Power Factor. *ACS Appl. Energy Mater.* **2019**, *2*, 6664–6671. [CrossRef]
130. Montgomery, D.S.; Hewitt, C.A.; Barbalace, R.; Jones, T.; Carroll, D.L. Spray doping method to create a low-profile high-density carbon nanotube thermoelectric generator. *Carbon* **2016**, *96*, 778–781. [CrossRef]
131. Van Toan, N.; Tuoi, T.T.K.; Ono, T. Thermoelectric generators for heat harvesting: From material synthesis to device fabrication. *Energy Convers. Management* **2020**, *225*, 113442. [CrossRef]
132. Rossella, F.; Pennelli, G.; Roddaro, S. Chapter Six—Measurement of the Thermoelectric Properties of Individual Nanostructures. *Semicond. Semimet.* **2018**, *98*, 409–444.
133. Samat, K.F.; Trung, N.H.; Ono, T. Enhancement in thermoelectric performance of electrochemically deposited platinum-bismuth telluride nanocomposite. *Electrochim. Acta* **2019**, *312*, 62–71. [CrossRef]
134. Bisht, N.; More, P.; Khanna, P.K.; Abolhassani, R. Progress of hybrid nanocomposite materials for thermoelectric applications. *Mater. Adv.* **2021**, *2*, 1927–1956. [CrossRef]
135. Giulia, P. Thermoelectric materials: The power of pores. *Nat. Rev. Mater.* **2017**, *2*, 17006. [CrossRef]
136. Xu, D.B.; Feng, T.M.; Agne, T.; Zhou, P.D.L.; Ruan, P.D.X.; Snyder, P.D.G.J.; Wu, P.D.Y. Highly Porous Thermoelectric Nanocomposites with Low Thermal Conductivity and High Figure of Merit from Large-Scale Solution-Synthesized Bi₂Te_{2.5}Se_{0.5} Hollow Nanostructures. *Angew. Chem. Int. Ed.* **2017**, *56*, 3546–3551. [CrossRef]
137. Ouyang, Z.; Li, D. Modelling of segmented high-performance thermoelectric generators with effects of thermal radiation, electrical and thermal contact resistances. *Sci. Rep.* **2016**, *6*, 24123. [CrossRef]
138. Kishore, R.A.; Sanghadasa, M.; Priya, S. Optimization of segmented thermoelectric generator using Taguchi and ANOVA techniques. *Sci. Rep.* **2017**, *7*, 16746. [CrossRef]
139. Hu, X.; Jood, P.; Ohta, M.; Kunii, M.; Nagase, K.; Nishiate, H.M.; Kanatzidis, G.; Yamamoto, A. Power generation from nanostructured PbTe-based thermoelectrics: Comprehensive development from materials to modules. *Energy Environ. Sci.* **2016**, *9*, 517–529. [CrossRef]
140. Zebarjadi, M. Heat Management in Thermoelectric Power Generators. *Sci. Rep.* **2016**, *6*, 20951. [CrossRef]
141. Lei, C.; Burton, M.; Nandhakumar, I.S. Facile production of thermoelectric bismuth telluride thick films in the presence of polyvinyl alcohol. *Phys. Chem. Chem. Phys.* **2016**, *18*, 14164–14167. [CrossRef]
142. Yin, Y.; Tiwari, A. Understanding the effect of thickness on the thermoelectric properties of Ca₃Co₄O₉ thin films. *Sci. Rep.* **2021**, *11*, 6324. [CrossRef]
143. Yan, J.; Liao, X.; Yan, D.; Chen, Y. Review of Micro Thermoelectric Generator. *J. Microelectromech. Syst.* **2018**, *27*, 1–18. [CrossRef]
144. Yang, Z.; PradoGonjal, J.; Phillips, M.; Lan, S.; Powell, A.; Vaqueiro, P.; Gao, M.; Stobart, R.; Chen, R. *Improved Thermoelectric Generator Performance Using High Temperature Thermoelectr Materials*; SAE International: Warrendale, PA, USA, 2017. [CrossRef]
145. Liu, W.; Hu, J.; Zhang, S.; Deng, M.; Han, C.; Liu, Y. New trends, strategies and opportunities in thermoelectric materials: A perspective. *Mater. Today Phys.* **2017**, *1*, 50–60. [CrossRef]
146. Smith, S. *Future of Thermoelectric Energy Harvesting Building and Home Automation Sectors will Drive Growth Opportunities for Thermal Harvesters*; Cision: London, UK, 2017.
147. Harrop, P.; Das, R. Thermoelectric Energy Harvesting and Sensing 2020–2030: New Principles, New Applications, Forecasts. Available online: <https://www.idtechex.com/en/research-report/thermoelectric-energy-harvesting-and-sensing-2020-2030/699> (accessed on 25 June 2021).
148. Freer, R.; Powell, A.V. Realising the potential of thermoelectric technology: A Roadmap. *J. Mater. Chem. C* **2019**, *8*, 441–463. [CrossRef]
149. Pedro, M.; Trinidad, P.; Carbajal, G. Potential use of Thermoelectric Generator Device for Air Conditioning System. In Proceedings of the 13th LACCEI Annual International Conference, Santo Domingo, Dominican, 29–31 July 2015.
150. Riffat, S.; Ma, X.; Wilson, R. Performance simulation and experimental testing of a novel thermoelectric heat pump system. *Appl. Therm. Eng.* **2006**, *26*, 494–501. [CrossRef]
151. Deng, F.; Qiu, H.; Chen, J.; Wang, L.; Wang, B. Wearable Thermoelectric Power Generators Combined With Flexible Supercapacitor for Low-Power Human Diagnosis Devices. *IEEE Trans. Ind. Electron.* **2016**, *64*, 1477–1485. [CrossRef]
152. Zhao, D.; Tan, G. A review of thermoelectric cooling: Materials, modeling and applications. *Appl. Therm. Eng.* **2014**, *66*, 15–24. [CrossRef]
153. Wilcoxon, R.; Collins, R. Avionics Thermal Management of Airborne Electronic. Available online: <https://www.electronics-cooling.com/2017/10/avionics-thermal-management-airborne-electronic-equipment-50-years-later/> (accessed on 25 June 2021).
154. Liu, J.; Hyland, M.; Hunter, H.M.; Hall, J.; Veety, E.; Vashaee, D. Wearable Thermoelectric Generators Powered by Body Heat. *HDIAC J.* **2017**, *4*, 4–8.
155. Kim, M.K.; Kim, M.S.; Jo, S.E.; Kim, H.L.; Lee, S.M.; Kim, Y.J. Wearable thermoelectric generator for human clothing applications. In Proceedings of the 17th International Conference on Solid-State Sensors, Actuators and Microsystems (TRANSDUCERS & EUROSENSORS XXVII), Barcelona, Spain, 16–20 June 2013; pp. 1376–1379.
156. Sun, S.L.; Dalton, R. Introduction to Organic Electronic and Optoelectronic Materials and Devices. In *Introduction to Organic Thermoelectric Materials and Devices*; CRC Press: London, UK, 2016; pp. 985–1021.

157. Shi, Y.; Wang, Y.; Mei, D.; Feng, B.; Chen, Z. Design and Fabrication of Wearable Thermoelectric Generator Device for Heat Harvesting. *IEEE Robot. Autom. Lett.* **2017**, *3*, 373–378. [[CrossRef](#)]
158. Irshad, K.; Almalawi, A.; Khan, A.I.; Alam, M.M.; Zahir, M.H.; Ali, A. An IoT-Based Thermoelectric Air Management Framework for Smart Building Applications: A Case Study for Tropical Climate. *Sustainability* **2020**, *12*, 1564. [[CrossRef](#)]
159. Ren, W.; Sun, Y.; Zhao, D.; Aili, A.; Zhang, S.; Shi, C.; Zhang, J.; Geng, H.; Zhang, J. High-performance wearable thermoelectric generator with self-healing, recycling, and Lego-like reconfiguring capabilities. *Sci. Adv.* **2020**, *7*. [[CrossRef](#)]
160. Proto, A.; Bibbo, D.; Cerny, M.; Vala, D.; Kašik, V.; Peter, L.; Conforto, S.; Schmid, M.; Penhaker, M. Thermal Energy Harvesting on the Bodily Surfaces of Arms and Legs through a Wearable Thermo-Electric Generator. *Sensors* **2018**, *18*, 1927. [[CrossRef](#)]
161. Li, L.; Chen, Z.; Zhou, M.; Huang, R. Developments in semiconductor thermoelectric materials. *Front. Energy* **2011**, *5*, 125–136. [[CrossRef](#)]
162. Paya, C.; le Corronc, E.; Pencole, Y. Detection of time shift failures in (max, +)-linear systems with time intervals applied to the supervision of assembly lines. In Proceedings of the 2019 IEEE International Conference on Systems, Man and Cybernetics (SMC), Bari, Italy, 6–9 October 2019; Volume 978, pp. 456–7281. [[CrossRef](#)]
163. Hyland, M.; Hunter, H.; Liu, J.; Veety, E.; Vashae, D. Wearable thermoelectric generators for human body heat harvesting. *Appl. Energy* **2016**, *182*, 518–524. [[CrossRef](#)]
164. Chen, Z.-G.; Han, G.; Yang, L.; Cheng, L.; Zou, J. Nanostructured thermoelectric materials: Current research and future challenge. *Prog. Nat. Sci.* **2012**, *22*, 535–549. [[CrossRef](#)]
165. Davis, S. Chapter 21: Thermoelectric Generators power. In *Power Management*; Prentice-Hall: Hoboken, NJ, USA, 2018.
166. Liu, W.; Jie, Q.; Kim, H.S.; Ren, Z. Current progress and future challenges in thermoelectric power generation: From materials to devices. *Acta Mater.* **2015**, *87*, 357–376. [[CrossRef](#)]
167. Goel, M.; Thelakkat, M. Polymer Thermoelectrics: Opportunities and Challenges. *Macromology* **2020**, *53*, 3632–3642. [[CrossRef](#)]
168. Aswal, D.K.; Basu, R.; Singh, A. Key issues in development of thermoelectric power generators: High figure-of-merit materials and their highly conducting interfaces with metallic interconnects. *Energy Convers. Manag.* **2016**, *114*, 50–67. [[CrossRef](#)]
169. Shuai, J.; Mao, J.; Song, S.; Zhang, Q.; Chen, G.; Ren, Z. Recent progress and future challenges on thermoelectric Zintl materials. *Mater. Today Phys.* **2017**, *1*, 74–95. [[CrossRef](#)]
170. O'Dwyer, C.; Chen, R.; Lee, J.K.; Razeeb, M. Scientific and Technical Challenges in Thermal Transport and Thermoelectric Materials and Devices. *ECS J. Solid State Sci. Technol.* **2017**, *6*, N3058–N3064. [[CrossRef](#)]
171. Ma, Z.; Wang, X.; Yang, A. Influence of Temperature on Characters of Thermoelectric Generators Based on Test Bed. *J. Nanomater.* **2014**, *2014*, 1–6. [[CrossRef](#)]
172. Tian, Z.; Lee, S.; Chen, G. *A Comprehensive Review of Heat Transfer in Thermoelectric Materials and Devices*; Massachusetts Institute of Technology: Cambridge, UK, 2014.
173. Ni, L.; Sun, K.; Wu, H.; Chen, Z.; Xing, Y. A high efficiency step-up DC-DC converter for thermoelectric generator with wide input voltage range. In Proceedings of the 2012 IEEE International Symposium on Industrial Electronics, Hangzhou, China, 28–31 May 2012; pp. 52–57.
174. Sahu, S.K.; Anil, B.K.; Abichandani, P.G.; Bas, A.S.; Sarkar, P.; Gupta, S.K.; Muth, M.K.P.; Gadkari, S.C. Design and development of DC to DC voltage booster to integrate with PbTe/TAGS-85 based thermoelectric power generators. *Mater. Sci. Energy Technol.* **2019**, *2*, 429–433. [[CrossRef](#)]
175. Brito, F.P.; Vieira, R.; Martins, J.; Goncalves, L.M.; Goncalves, A.P.; Coelho, R.; Lopes, E.B.; Symeoud, E.; Kyratsi, T. Analysis of thermoelectric generator incorporating n-magnesium silicide and p-tetrahydrite materials. *Energy Convers. Manag.* **2021**, *236*, 114003. [[CrossRef](#)]
176. Piggott, A. Detailed Transient Multiphysics Model for Fast and Accurate Design, Simulation and Optimization of a Thermoelectric Generator (TEG) or Thermal Energy Harvesting Device. *J. Electron. Mater.* **2019**, *48*, 5442–5452. [[CrossRef](#)]
177. Kumar, N.; Setia, V.; Patel, S.K.; Upadhyay, S.; Chauhan, S.; Bajpai, P. Analysis of Energy Generation from Exhaust of Automobile using Peltier (Thermoelectric Generator). *Int. J. Trend Sci. Res. Dev.* **2019**, *3*, 2456–6470. [[CrossRef](#)]
178. Daniel, C. *Thermoelectric Applications*; Laboratoire des Sciences de l'Ingénieur Appliquées à la Mécanique: Pau, France, 2014.
179. Du, Y.; Xu, J.; Paul, B.; Eklund, P. Flexible thermoelectric materials and devices. *Appl. Mater. Today* **2018**, *12*, 366–388. [[CrossRef](#)]
180. Patel, D.; Shruti, M.B.; Patel, D. Review of Use of Thermoelectricity as Renewable Energy Source. *J. Emerg. Technol. Innov. Res.* **2015**, *2*, 835–839.
181. Bouchard, J.; Leblanc, G.; Levesque, M.; Radziszewski, P.; Georges-Filteau, D. Breaking down energy consumption in industrial grinding mills. *CIM J.* **2019**, *10*, 157–164. [[CrossRef](#)]