



HAL
open science

Optimal Control of Timed Event Graphs with Resource Sharing and Output-Reference Update

Germano Schafaschek, Soraia Moradi, Laurent Hardouin, Jörg Raisch

► **To cite this version:**

Germano Schafaschek, Soraia Moradi, Laurent Hardouin, Jörg Raisch. Optimal Control of Timed Event Graphs with Resource Sharing and Output-Reference Update. 15th IFAC Workshop on Discrete Event Systems, Nov 2020, Rio de Janeiro, Brazil. hal-03223277

HAL Id: hal-03223277

<https://univ-angers.hal.science/hal-03223277v1>

Submitted on 10 May 2021

HAL is a multi-disciplinary open access archive for the deposit and dissemination of scientific research documents, whether they are published or not. The documents may come from teaching and research institutions in France or abroad, or from public or private research centers.

L'archive ouverte pluridisciplinaire **HAL**, est destinée au dépôt et à la diffusion de documents scientifiques de niveau recherche, publiés ou non, émanant des établissements d'enseignement et de recherche français ou étrangers, des laboratoires publics ou privés.



Distributed under a Creative Commons Attribution - NonCommercial - NoDerivatives 4.0 International License

Optimal Control of Timed Event Graphs with Resource Sharing and Output-Reference Update^{*}

Germano Schafaschek^{*} Soraia Moradi^{*} Laurent Hardouin^{**}
Jörg Raisch^{*}

^{*} *Fachgebiet Regelungssysteme, Technische Universität Berlin,
Germany (e-mail: [schafaschek,moradi,raisch]@control.tu-berlin.de)*

^{**} *Laboratoire Angevin de Recherche en Ingénierie des Systèmes,
Université d'Angers, France (e-mail: laurent.hardouin@univ-angers.fr)*

Abstract: Discrete-event systems exhibiting synchronization and delay phenomena, but not conflict, can be modeled as timed event graphs (TEGs), which admit a linear representation in some idempotent semirings. For such linear systems, a control theory has been constructed. In this paper, we build onto this control framework by proposing a formal method to determine the optimal (just-in-time) control inputs in face of changes in the output-references for a number of TEGs that share one or more resources. The approach is based on a prespecified priority policy among the component subsystems. Simple examples are presented to illustrate the results.

Keywords: Timed event graphs, idempotent semirings, just-in-time control, min-plus algebra.

1. INTRODUCTION

Timed event graphs (TEGs) constitute a subclass of timed Petri nets, being characterized by the fact that each place has precisely one upstream and one downstream transition and all arcs have weight 1. They are well suited to model timed discrete-event systems exhibiting synchronization and delay phenomena. In some idempotent semirings, like the max-plus and min-plus algebras, it is possible to represent the dynamic behavior of TEGs by linear models (see Baccelli et al. (1992) for a thorough coverage), which can serve as a basis for performance evaluation as well as for control. In this context, *optimal* control normally refers to a *just-in-time* philosophy: given an output-reference specifying, say, a desired production schedule, the aim is to determine the latest possible way to fire the input transitions while guaranteeing that the output ones fire not later than required. In industrial applications, for example, this amounts to satisfying customer demand while minimizing internal stocks. For a tutorial introduction to this control framework, the reader may refer to Hardouin et al. (2018).

In some applications, it may be necessary to update the reference for the system's output during run-time, for instance when customer demand is increased and a new production objective must be considered. In Menguy et al. (2000), a strategy has been presented to optimally update the input in face of such changes in the output-reference.

Systems of practical interest often involve limited resources that are shared among different users (subsystems). As examples, one can think of a railway network where single-track segments are used by multiple trains, or of computational tasks competing for the use of a fixed number of

processors. TEGs do not allow for concurrency or choice and hence are inapt to model such resource-sharing phenomena. Overcoming this limitation has motivated several efforts in the literature. In Corrêa et al. (2009), constraints due to resource sharing are translated into additional inequalities in the system model. Addad et al. (2012) model conflicting TEGs by max-plus time-varying equations; the models are restricted to safe conflict places. Boussahel et al. (2016) relax the safety hypothesis on the conflict places and study cycle time evaluation on conflicting TEGs with multiple shared resources. In Moradi et al. (2017), the modeling and control of a number of TEGs that share multiple resources is addressed. Obviously, because of resource sharing, the overall system is no longer a TEG. Under a prespecified priority policy, the authors show how to compute the optimal (just-in-time) input for each subsystem with respect to its individual output-reference.

In this paper, we propose a formal method to obtain the optimal control inputs in face of changes in the output-references for TEGs that share resources under a given priority policy, thus merging the results from Menguy et al. (2000) with those of Moradi et al. (2017). To the best of our knowledge, this problem has not been previously handled in the literature. Prospective applications include emergency call centers (as studied, e.g., in Allamigeon et al. (2015)), where the arrival of high-priority calls may render it necessary to reschedule the answers to lower-priority ones. We consider a set of TEGs operating under optimal schedules with respect to their individual output-references and to the priority policy; supposing the output-reference of one or more of the subsystems is updated during run-time, we show how to optimally update all their inputs so that their outputs are as close as possible to the corresponding new references and the priority policy is still observed. In case the performance limitation of the

^{*} Financial support from Deutsche Forschungsgemeinschaft (DFG) via grant RA 516/14-1 is gratefully acknowledged.

subsystems, combined with the limited availability of the resources, make it impossible to respect some of the new references, we also provide the optimal way to relax such references so that the ultimately obtained inputs lead to tracking them as closely as possible.

The examples presented along this paper serve solely the purpose of illustrating and helping elucidating the results. Due to space limitations, we do not present a more comprehensive example. The proposed method can, however, be applied to larger, more general systems of practical relevance (see Section 5.3 for further comments).

The paper is organized as follows. Section 2 summarizes well-known facts on idempotent semirings. In Section 3, we adapt existing results on the control of TEGs with output-reference update to the idempotent semiring used in this paper. Section 4 provides an overview of previous results on modeling and control of TEGs with shared resources. The major purpose of these three sections is making the paper as self-contained as possible. In Section 5, the main contributions of the paper are presented; namely, we formulate and solve the problem of determining the optimal control inputs for TEGs with shared resources in face of changes in the output-references. Section 6 presents the conclusions and final remarks.

2. PRELIMINARIES

In this section, we present a summary of some basic definitions and results on idempotent semirings and timed event graphs; for an exhaustive discussion, the reader may refer to Baccelli et al. (1992). We also touch on some topics from residuation theory and control of TEGs (see Blyth and Janowitz (1972) and Hardouin et al. (2018), respectively).

2.1 Idempotent semirings

An *idempotent semiring* \mathcal{D} is a set D endowed with two binary operations, denoted \oplus (*sum*) and \otimes (*product*), such that: \oplus is associative, commutative, idempotent (i.e., $(\forall a \in \mathcal{D}) a \oplus a = a$), and has a neutral (*zero*) element, denoted ε ; \otimes is associative, distributes over \oplus , and has a neutral (*unit*) element, denoted e ; the element ε is absorbing for \otimes (i.e., $(\forall a \in \mathcal{D}) a \otimes \varepsilon = \varepsilon$). As in conventional algebra, the product symbol \otimes is often omitted. An order relation can be defined over \mathcal{D} by

$$(\forall a, b \in \mathcal{D}) a \preceq b \Leftrightarrow a \oplus b = b.$$

Note that ε is the bottom element of \mathcal{D} , as $(\forall a \in \mathcal{D}) \varepsilon \preceq a$.

An idempotent semiring \mathcal{D} is *complete* if it is closed for infinite sums and if the product distributes over infinite sums. For a complete idempotent semiring, the top element is defined as $\top = \bigoplus_{x \in \mathcal{D}} x$, and the *greatest lower bound* operation, denoted \wedge , by

$$(\forall a, b \in \mathcal{D}) a \wedge b = \bigoplus_{x \preceq a, x \preceq b} x.$$

\wedge is associative, commutative, and idempotent, and we have $a \oplus b = b \Leftrightarrow a \preceq b \Leftrightarrow a \wedge b = a$.

Example 1. The set $\overline{\mathbb{Z}} \stackrel{\text{def}}{=} \mathbb{Z} \cup \{-\infty, +\infty\}$, with the *minimum* operation as \oplus and conventional addition as \otimes , forms a complete idempotent semiring called *min-plus algebra*,

denoted $\overline{\mathbb{Z}}_{\min}$, in which $\varepsilon = +\infty$, $e = 0$, and $\top = -\infty$. Note that in $\overline{\mathbb{Z}}_{\min}$ we have $2 \oplus 5 = 2$, so $5 \preceq 2$; the order is reversed with respect to the conventional order over \mathbb{Z} . \diamond

A mapping $\Pi : \mathcal{D} \rightarrow \mathcal{C}$, with \mathcal{D} and \mathcal{C} two idempotent semirings, is *isotone* if $(\forall a, b \in \mathcal{D}) a \preceq b \Rightarrow \Pi(a) \preceq \Pi(b)$.

Remark 2. The composition of two isotone mappings is isotone. \diamond

Remark 3. Let Π be an isotone mapping over a complete idempotent semiring \mathcal{D} , and let $\mathcal{Y} = \{x \in \mathcal{D} \mid \Pi(x) = x\}$ be the set of fixed points of Π . $\bigwedge_{y \in \mathcal{Y}} y$ (resp. $\bigoplus_{y \in \mathcal{Y}} y$) is the least (resp. greatest) fixed point of Π . \diamond

Algorithms exist (e. g., Hardouin et al. (2018)) which allow to compute, in a finite number of steps, the least and greatest fixed points of isotone mappings over complete idempotent semirings, provided such fixed points are finite.

In a complete idempotent semiring \mathcal{D} , the Kleene star operator on $a \in \mathcal{D}$ is defined as $a^* = \bigoplus_{i \geq 0} a^i$, with $a^0 = e$.

Remark 4. The implicit equation $x = ax \oplus b$ over a complete idempotent semiring admits $x = a^*b$ as least solution (see Baccelli et al. (1992)). \diamond

2.2 Semirings of formal power series

Let $s = \{s(t)\}_{t \in \overline{\mathbb{Z}}}$ be a sequence over $\overline{\mathbb{Z}}_{\min}$. The δ -transform of s is a formal power series in δ with coefficients in $\overline{\mathbb{Z}}_{\min}$ and exponents in $\overline{\mathbb{Z}}$, defined by

$$s = \bigoplus_{t \in \overline{\mathbb{Z}}} s(t) \delta^t.$$

We denote both the sequence and its δ -transform by the same symbol, as no ambiguity will occur. Since

$$s \otimes \delta = \bigoplus_{t \in \overline{\mathbb{Z}}} s(t) \otimes \delta^{t+1} = \bigoplus_{t \in \overline{\mathbb{Z}}} s(t-1) \otimes \delta^t,$$

multiplication by δ can be seen as a backward shift operation.

Definition 5. The set of formal power series in δ with coefficients in $\overline{\mathbb{Z}}_{\min}$ and exponents in $\overline{\mathbb{Z}}$, with addition and multiplication defined by

$$\begin{aligned} s \oplus s' &= \bigoplus_{t \in \overline{\mathbb{Z}}} (s(t) \oplus s'(t)) \delta^t, \\ s \otimes s' &= \bigoplus_{t \in \overline{\mathbb{Z}}} \left(\bigoplus_{\tau \in \overline{\mathbb{Z}}} (s(\tau) \otimes s'(t-\tau)) \right) \delta^t, \end{aligned}$$

is a complete idempotent semiring, denoted $\overline{\mathbb{Z}}_{\min}[[\delta]]$. Note that the order in $\overline{\mathbb{Z}}_{\min}[[\delta]]$ is induced by the order in $\overline{\mathbb{Z}}_{\min}$, i.e., $s \preceq s' \Leftrightarrow (\forall t \in \overline{\mathbb{Z}}) s(t) \preceq s'(t)$. \diamond

In this paper we will use sequences to represent the number of firings of transitions in TEGs, so that, e.g., $s(t)$ represents the accumulated number of firings of a transition up to time t . Such sequences are clearly nonincreasing (in the order of $\overline{\mathbb{Z}}_{\min}$), meaning their δ -transforms obey $s(t-1) \succeq s(t)$ for all t . We will henceforth refer to such series s as *counters*.

Definition 6. The set of counters (i.e., nonincreasing power series) in $\overline{\mathbb{Z}}_{\min}[[\delta]]$ is a complete idempotent semiring, named $\overline{\mathbb{Z}}_{\min, \delta}[[\delta]]$, with zero element s_ε given by $s_\varepsilon(t) = \varepsilon$ for all t , unit element s_e given by $s_e(t) = e$ for $t \leq 0$ and

$s_e(t) = \varepsilon$ for $t > 0$, and top element s_\top given by $s_\top(t) = \top$ for all t . We will denote this semiring by Σ , for brevity. \diamond

Counters can be represented compactly by omitting terms $s(t)\delta^t$ whenever $s(t) = s(t+1)$. For example, a counter s with $s(t) = e$ for $t \leq 3$, $s(t) = 1$ for $4 \leq t \leq 7$, $s(t) = 3$ for $8 \leq t \leq 12$, and $s(t) = 6$ for $t \geq 13$ can be written $s = e\delta^3 \oplus 1\delta^7 \oplus 3\delta^{12} \oplus 6\delta^{+\infty}$.

2.3 TEG models in idempotent semirings

Timed event graphs (TEGs) are timed Petri nets in which each place has exactly one upstream and one downstream transition and all arcs have weight 1. With each place p is associated a *holding time*, representing the minimum time every token needs to spend in p before it can contribute to the firing of its downstream transition. In a TEG, we can distinguish input transitions (those that are not affected by the firing of other transitions), output transitions (those that do not affect the firing of other transitions), and internal transitions (those that are neither input nor output transitions). In this paper, we will limit our discussion to SISO TEGs, i. e., TEGs with only one input and one output transition, which we denote respectively by u and y ; internal transitions are denoted by x_i . An example of a SISO TEG is shown in Fig. 1.

A TEG is said to be operating under the *earliest firing rule* if every transition fires as soon as it is enabled.

With each transition x_i , we associate a sequence $\{x_i(t)\}_{t \in \mathbb{Z}}$, for simplicity denoted by the same symbol, where $x_i(t)$ represents the accumulated number of firings of x_i up to and including time t . Similarly, we associate sequences $\{u(t)\}_{t \in \mathbb{Z}}$ and $\{y(t)\}_{t \in \mathbb{Z}}$ with transitions u and y , respectively. In \mathbb{Z}_{\min} , the number of firings of transition x_1 of the TEG from Fig. 1 follows, under the earliest firing rule,

$$(\forall t \in \mathbb{Z}) \quad x_1(t) = u(t) \oplus 2x_2(t-2),$$

which, through the δ -transform, can be expressed in Σ as

$$x_1 = u \oplus 2\delta^2 x_2.$$

We can obtain similar relations for x_2 and y and, defining the vector $x = \begin{bmatrix} x_1 \\ x_2 \end{bmatrix}$, write

$$\begin{aligned} x &= \begin{bmatrix} \varepsilon & 2\delta^2 \\ e\delta^3 & \varepsilon \end{bmatrix} x \oplus \begin{bmatrix} e\delta^0 \\ \varepsilon \end{bmatrix} u, \\ y &= \begin{bmatrix} \varepsilon & e\delta^0 \end{bmatrix} x. \end{aligned}$$

In general, a TEG can be described by implicit equations over Σ of the form

$$\begin{aligned} x &= Ax \oplus Bu, \\ y &= Cx. \end{aligned} \quad (1)$$

From Remark 4, the least solution of (1) is given by

$$y = CA^*Bu, \quad (2)$$

where $G = CA^*B$ is the *transfer function* of the system. For instance, for the system from Fig. 1 we obtain the (scalar) transfer function $G = e\delta^3(2\delta^5)^*$.

2.4 Residuation theory

Residuation theory provides, under certain conditions, greatest (resp. least) solutions to inequalities such as $f(x) \preceq b$ (resp. $f(x) \succeq b$).

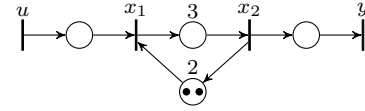

Fig. 1. A SISO TEG, with input u and output y .

Definition 7. An isotone mapping $f : \mathcal{D} \rightarrow \mathcal{C}$, with \mathcal{D} and \mathcal{C} complete idempotent semirings, is said to be residuated if for all $y \in \mathcal{C}$ there exists a greatest solution to the inequality $f(x) \preceq y$. This greatest solution is denoted $f^\sharp(y)$, and the mapping $f^\sharp : \mathcal{C} \rightarrow \mathcal{D}$, $y \mapsto \bigoplus \{x \in \mathcal{D} \mid f(x) \preceq y\}$, is called the *residual* of f .

Mapping f is said to be dually residuated if for all $y \in \mathcal{C}$ there exists a least solution to the inequality $f(x) \succeq y$. This least solution is denoted $f^\flat(y)$, and the mapping $f^\flat : \mathcal{C} \rightarrow \mathcal{D}$, $y \mapsto \bigwedge \{x \in \mathcal{D} \mid f(x) \succeq y\}$, is called the *dual residual* of f . \diamond

Note that, if equality $f(x) = y$ is solvable, $f^\sharp(y)$ and $f^\flat(y)$ yield its greatest and least solutions, respectively.

Theorem 8. (Blyth and Janowitz (1972)) Mapping f as in Def. 7 is residuated if and only if there exists a unique isotone mapping $f^\sharp : \mathcal{C} \rightarrow \mathcal{D}$ such that $f \circ f^\sharp \preceq \text{Id}_{\mathcal{C}}$ and $f^\sharp \circ f \succeq \text{Id}_{\mathcal{D}}$, where $\text{Id}_{\mathcal{C}}$ and $\text{Id}_{\mathcal{D}}$ are the identity mappings on \mathcal{C} and \mathcal{D} , respectively. \diamond

Remark 9. For $a \in \mathcal{D}$, mapping $L_a : \mathcal{D} \rightarrow \mathcal{D}$, $x \mapsto a \otimes x$, is residuated; its residual is denoted by $L_a^\sharp(x) = a\phi x$. \diamond

Theorem 10. (Blyth and Janowitz (1972)) Mapping f as in Def. 7 is dually residuated if and only if $f(\top) = \top$ and $(\forall \mathcal{A} \subseteq \mathcal{D}) f(\bigwedge_{x \in \mathcal{A}} x) = \bigwedge_{x \in \mathcal{A}} f(x)$. \diamond

2.5 Optimal control of TEGs

Assume that a TEG to be controlled is modeled by equations like (1) and that an output-reference $z \in \Sigma$ is given. Under the just-in-time paradigm, we aim at firing the input transition u the least possible number of times while guaranteeing that the output transition y fires, by each time instant, at least as many times as specified by z . In other words, we seek the greatest (in the order of \mathbb{Z}_{\min}) u such that $y = G \otimes u \preceq z$. Based on (2) and Remark 9, the solution is directly obtained by

$$u_{\text{opt}} = G\phi z. \quad (3)$$

Example 11. For the TEG from Fig. 1, suppose it is required that transition y fires once at time $t = 43$, twice at $t = 47$, and three times at $t = 55$, meaning the accumulated number of firings of y should be $e (= 0)$ for $t \leq 42$, 1 for $43 \leq t \leq 46$, 3 for $47 \leq t \leq 54$, and 6 for $t \geq 55$. This is represented by the output-reference $z = e\delta^{42} \oplus 1\delta^{46} \oplus 3\delta^{54} \oplus 6\delta^{+\infty}$. Applying (3), we get $u_{\text{opt}} = e\delta^{38} \oplus 1\delta^{41} \oplus 2\delta^{43} \oplus 3\delta^{46} \oplus 4\delta^{51} \oplus 6\delta^{+\infty}$, and the corresponding optimal output is $y_{\text{opt}} = G \otimes u_{\text{opt}} = e\delta^{41} \oplus 1\delta^{44} \oplus 2\delta^{46} \oplus 3\delta^{49} \oplus 4\delta^{54} \oplus 6\delta^{+\infty}$. One can verify that

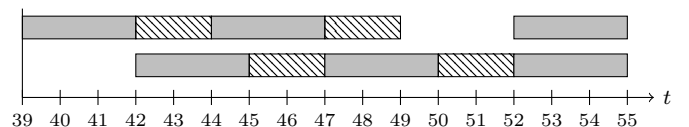

Fig. 2. Optimal schedule obtained in Example 11; the gray bars represent the operation of the system, and the dashed bars are the delays imposed by the resource.

$y_{\text{opt}} \preceq z$. Interpreting the places between x_1 and x_2 as the operation of the system (top) and a double-capacity resource (bottom), the optimal schedule obtained above can be displayed in a chart as shown in Fig. 2, where each row corresponds to one instance of the resource. \diamond

3. OPTIMAL CONTROL OF TEGS WITH OUTPUT-REFERENCE UPDATE

The material of this section is a dual version, adapted to the point of view of counters, of the results from Menguy et al. (2000).

It is plausible to consider that the reference for the output of a system may be updated during run-time, for instance when customer demand is increased and a new production objective must be taken into account. For a system like the one from Example 11, let reference z be updated to a new one, z' , at time T . The problem at hand is to find the input u'_{opt} which optimally tracks z' without, however, changing the inputs given up to time T . Define the mapping $r_T : \Sigma \rightarrow \Sigma$,

$$[r_T(u)](t) = \begin{cases} u(t), & \text{if } t \leq T; \\ \varepsilon, & \text{if } t > T. \end{cases} \quad (4)$$

Our objective can then be restated as follows: find the greatest element u'_{opt} of the set

$$\mathcal{F} = \{u \in \Sigma \mid G \otimes u \preceq z' \text{ and } r_T(u) = r_T(u_{\text{opt}})\},$$

where u_{opt} is the optimal input with respect to reference z , computed as in (3). The following theorem provides, given that certain conditions are met, a way to compute this greatest element.

Theorem 12. (Menguy et al. (2000)) Let \mathcal{D} and \mathcal{C} be complete idempotent semirings, $f_1, f_2 : \mathcal{D} \rightarrow \mathcal{C}$ residuated mappings, and $c_1, c_2 \in \mathcal{C}$. If the set

$$\mathcal{S} = \{x \in \mathcal{D} \mid f_1(x) \preceq c_1 \text{ and } f_2(x) = c_2\}$$

is nonempty, we have $\bigoplus_{x \in \mathcal{S}} x = f_1^\sharp(c_1) \wedge f_2^\sharp(c_2)$. \diamond

An obvious correspondence between \mathcal{F} and \mathcal{S} can be established by taking \mathcal{D} as Σ , f_1 as L_G (which is well known to be residuated — see Remark 9), c_1 as z' , f_2 as r_T , and c_2 as $r_T(u_{\text{opt}})$.

Remark 13. Mapping r_T as defined in (4) is residuated, with

$$[r_T^\sharp(u)](t) = \begin{cases} u(t), & \text{if } t \leq T; \\ u(T), & \text{if } t > T. \end{cases}$$

In fact, r_T^\sharp is clearly isotone and we have¹ $r_T \circ r_T^\sharp = r_T \preceq \text{Id}_\Sigma$ and $r_T^\sharp \circ r_T = r_T^\sharp \succeq \text{Id}_\Sigma$, so the conditions from Theorem 8 are fulfilled. \diamond

Hence, if set \mathcal{F} is nonempty, Theorem 12 provides the desired solution u'_{opt} . In general, however, \mathcal{F} can be empty. Considering the set

$$\tilde{\mathcal{F}} = \{u \in \Sigma \mid r_T(u) = r_T(u_{\text{opt}})\},$$

it is easy to see that

$$\underline{u} \stackrel{\text{def}}{=} \bigwedge_{u \in \tilde{\mathcal{F}}} u = r_T(u_{\text{opt}}).$$

¹ Note that the order \preceq on Σ induces an order, for simplicity also denoted \preceq , on the set of mappings over Σ : for any such mappings Θ_1, Θ_2 , one has $\Theta_1 \preceq \Theta_2 \Leftrightarrow (\forall x \in \Sigma) \Theta_1(x) \preceq \Theta_2(x)$.

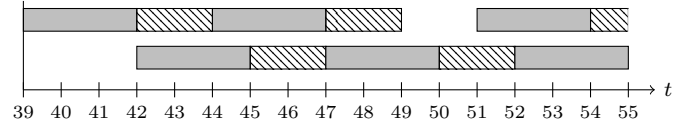

Fig. 3. Updated optimal schedule obtained in Example 15; the gray bars represent the operation of the system, whereas the dashed bars are the delays imposed by the resource.

Moreover, $r_T \circ r_T = r_T$ implies $\underline{u} \in \tilde{\mathcal{F}}$, as $r_T(\underline{u}) = r_T(r_T(u_{\text{opt}})) = r_T(u_{\text{opt}})$; isotony of L_G thus implies

$$\mathcal{F} \neq \emptyset \Leftrightarrow G \otimes \underline{u} \preceq z'.$$

Since the condition $r_T(u) = r_T(u_{\text{opt}})$ cannot be relaxed, in case $G \otimes \underline{u} \not\preceq z'$ we must increase z' ; more precisely, we wish to find the least counter $z'' \succeq z'$ such that

$$\mathcal{F}_{z''} = \{u \in \Sigma \mid G \otimes u \preceq z'' \text{ and } r_T(u) = r_T(u_{\text{opt}})\}$$

is not empty. The following result provides the answer.

Proposition 14. The least counter $z'' \succeq z'$ such that $\mathcal{F}_{z''} \neq \emptyset$ is $z'' = z' \oplus (G \otimes \underline{u})$.

Proof. For $z'' = z' \oplus (G \otimes \underline{u})$, we have $\underline{u} \in \mathcal{F}_{z''}$, therefore $\mathcal{F}_{z''} \neq \emptyset$. Take now an arbitrary $\tilde{z}'' \succeq z''$ such that $\mathcal{F}_{\tilde{z}''} \neq \emptyset$, and take any $v \in \mathcal{F}_{\tilde{z}''}$. Clearly $v \in \tilde{\mathcal{F}}$ and hence $\underline{u} \preceq v$; as L_G is isotone, we have $G \otimes \underline{u} \preceq G \otimes v \preceq \tilde{z}''$, implying $z'' = z' \oplus (G \otimes \underline{u}) \preceq z' \oplus \tilde{z}'' = \tilde{z}''$. \square

Applying Theorem 12 and recalling that $r_T^\sharp \circ r_T = r_T^\sharp$, we obtain

$$u'_{\text{opt}} = G \diamond (z' \oplus (G \otimes \underline{u})) \wedge r_T^\sharp(u_{\text{opt}}). \quad (5)$$

Note that in case $\mathcal{F} \neq \emptyset$ we have $z'' = z' \oplus (G \otimes \underline{u}) = z'$.

Example 15. For the system from Example 11 (Fig. 1) operating according to the optimal input obtained for output-reference z , suppose that at time $T = 42$ a new demand is received: three firings of y are now required at $t = 54$ (instead of at $t = 55$). This translates to $z' = e\delta^{42} \oplus 1\delta^{46} \oplus 3\delta^{53} \oplus 6\delta^{+\infty}$. In this case one can verify that set \mathcal{F} is empty, so we seek the least $z'' \succeq z'$ such that $\mathcal{F}_{z''} \neq \emptyset$, according to Proposition 14. With $\underline{u} = r_T(u_{\text{opt}}) = e\delta^{38} \oplus 1\delta^{41} \oplus 2\delta^{42} \oplus \varepsilon\delta^{+\infty}$, we obtain $z'' = z' \oplus (G \otimes \underline{u}) = e\delta^{42} \oplus 1\delta^{46} \oplus 3\delta^{53} \oplus 5\delta^{54} \oplus 6\delta^{+\infty}$, which is the reference we will effectively track. From (5), we get $u'_{\text{opt}} = e\delta^{38} \oplus 1\delta^{41} \oplus 2\delta^{43} \oplus 3\delta^{46} \oplus 4\delta^{50} \oplus 5\delta^{51} \oplus 6\delta^{+\infty}$, and hence $y'_{\text{opt}} = e\delta^{41} \oplus 1\delta^{44} \oplus 2\delta^{46} \oplus 3\delta^{49} \oplus 4\delta^{53} \oplus 5\delta^{54} \oplus 6\delta^{+\infty}$. The updated optimal schedule is shown in Fig. 3, to be interpreted as explained in Example 11. \diamond

4. MODELING AND OPTIMAL CONTROL OF TEGS WITH RESOURCE SHARING

We now turn our attention to systems in which a number of TEGs S^1, \dots, S^K share a resource, as illustrated in Fig. 4. H^k represents the internal dynamics of S^k . β may, in general, be a TEG (or, in simple cases, just a single place) describing the capacity of the resource as well as the minimal delay between release and allocation events. Clearly, the overall system is no longer a TEG. For simplicity, let us assume that there is only one shared resource (with arbitrary capacity) and that input transitions (u^k) are connected to resource-allocation transitions (x_A^k) via a single place with zero delay and no initial tokens, the same

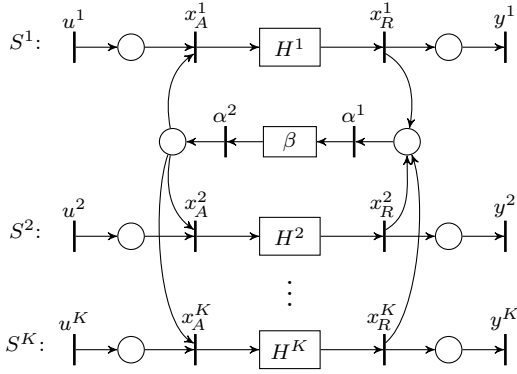

Fig. 4. A number of TEGs with a shared resource.

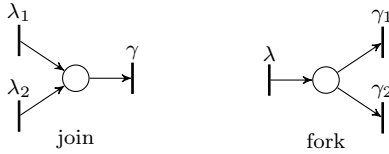

Fig. 5. A join and a fork structure.

being true for the connection between resource-release transitions (x_R^k) and output transitions (y^k). The extension to more general cases is straightforward; for details, the reader is referred to Moradi et al. (2017), on which this section is mainly based.

4.1 Modeling of TEGs with shared resources

It is not possible to model systems exhibiting such resource-sharing phenomena by linear equations like (1). In order to express the relationship among counters x_A^k and x_R^k , $k \in \{1, \dots, K\}$, the *Hadamard product* of series is introduced (Hardouin et al. (2008)).

Definition 16. The Hadamard product of $s_1, s_2 \in \Sigma$, written $s_1 \odot s_2$, is the counter defined as follows:

$$(\forall t \in \overline{\mathbb{Z}}) (s_1 \odot s_2)(t) = s_1(t) \otimes s_2(t).$$

This operation is commutative, distributes over \oplus and \wedge , has neutral element $e\delta^{+\infty}$, and s_ε is absorbing for it (i. e., $(\forall s \in \Sigma) s \odot s_\varepsilon = s_\varepsilon$). \diamond

Consider a *join* structure (i. e., a place with two or more incoming transitions) as shown in Fig. 5. At any time instant t , the accumulated number of firings of γ cannot exceed that of λ_1 and λ_2 combined, which translates to $\lambda_1 \odot \lambda_2 \preceq \gamma$.

Similarly, for a *fork* structure (i. e., a place with two or more outgoing transitions) such as the one shown in Fig. 5, the accumulated number of firings of γ_1 and γ_2 combined can never exceed that of λ , meaning $\lambda \preceq \gamma_1 \odot \gamma_2$.

Generalizing these ideas allows us to write, for the system from Fig. 4,

$$x_R^1 \odot \dots \odot x_R^K \preceq \alpha_1 \quad \text{and} \quad \alpha_2 \preceq x_A^1 \odot \dots \odot x_A^K$$

which, combined with $\beta \otimes \alpha_1 \preceq \alpha_2$, leads to

$$\beta \otimes \left(\bigodot_{k=1}^K x_R^k \right) \preceq \bigodot_{k=1}^K x_A^k. \quad (6)$$

4.2 Optimal control of TEGs with resource sharing

For a system like the one from Fig. 4, competition for the resource is, in general, going to make it impossible for all subsystems to concurrently follow a just-in-time schedule with respect to their individual output-references. One way to settle the dispute is introducing a priority policy among the subsystems. We henceforth assume, without loss of generality, that subsystem S^k has higher priority than S^{k+1} , for all $k \in \{1, \dots, K-1\}$. The priority policy is based on a simple rule: for each $k \in \{2, \dots, K\}$ and for all $j \in \{1, \dots, k-1\}$, S^k cannot interfere with the performance of S^j .

Let the input-output behavior of each S^k , ignoring all other subsystems, be described by $y^k = G^k \otimes u^k$ — which, according to the assumptions made above, is equivalent to $x_R^k = G^k \otimes x_A^k$ — and assume that corresponding references z^k are given. The subsystem with highest priority, S^1 , is free to use the resource at will; therefore, we can effectively neglect all other subsystems and simply compute its optimal input by $u_{\text{opt}}^1 = x_{A_{\text{opt}}}^1 = G^1 \backslash z^1$ (cf. Section 2.5).

For S^2 , we must compute the optimal input under the restriction that the optimal behavior of S^1 is unchanged; based on (6), this means we must respect

$$\beta \otimes (x_{R_{\text{opt}}}^1 \odot x_R^2) \preceq x_{A_{\text{opt}}}^1 \odot x_A^2. \quad (7)$$

In fact, we want to determine the greatest x_A^2 — and thus also the corresponding u^2 — fulfilling both $G^2 \otimes u^2 \preceq z^2$ and (7); seeing that (7) implies

$$x_{R_{\text{opt}}}^1 \odot x_R^2 \preceq \beta \backslash (x_{A_{\text{opt}}}^1 \odot x_A^2), \quad (8)$$

the following result comes in handy.

Proposition 17. (Hardouin et al. (2008)) For any $a \in \Sigma$, the mapping $\Pi_a : \Sigma \rightarrow \Sigma$, $x \mapsto a \odot x$, is residuated. For any $b \in \Sigma$, $\Pi_a^\#(b)$, denoted $b \odot^\# a$, is the greatest $x \in \Sigma$ such that $a \odot x \preceq b$. \diamond

From Proposition 17, inequality (8) leads to

$$x_R^2 \preceq (\beta \backslash (x_{A_{\text{opt}}}^1 \odot x_A^2)) \odot^\# x_{R_{\text{opt}}}^1$$

which, combined with $x_R^2 = G^2 \otimes x_A^2 \preceq z^2$, implies

$$x_A^2 \preceq G^2 \backslash [(\beta \backslash (x_{A_{\text{opt}}}^1 \odot x_A^2)) \odot^\# x_{R_{\text{opt}}}^1] \wedge G^2 \backslash z^2. \quad (9)$$

The greatest x_A^2 satisfying (9), $x_{A_{\text{opt}}}^2$, is the greatest fixed point (provided it exists) of the mapping $\Phi^2 : \Sigma \rightarrow \Sigma$,

$$\Phi^2(x_A^2) = G^2 \backslash [(\beta \backslash (x_{A_{\text{opt}}}^1 \odot x_A^2)) \odot^\# x_{R_{\text{opt}}}^1] \wedge G^2 \backslash z^2 \wedge x_A^2. \quad (10)$$

As Φ^2 can be verified to be isotone (see Remark 2), Remark 3 ensures the existence of its greatest fixed point, which yields the desired optimal solution $x_{A_{\text{opt}}}^2 (= u_{\text{opt}}^2)$.

Using the same procedure, we obtain, for each k ,

$$x_A^k \preceq G^k \backslash \left[\left(\beta \backslash \left(\left(\bigodot_{i=1}^{k-1} x_{A_{\text{opt}}}^i \right) \odot x_A^k \right) \right) \odot^\# \left(\bigodot_{i=1}^{k-1} x_{R_{\text{opt}}}^i \right) \right] \wedge G^k \backslash z^k$$

and, defining a mapping Φ^k by analogy with (10), its greatest fixed point provides $x_{A_{\text{opt}}}^k$ and, therefore, also u_{opt}^k .

Example 18. Consider the system from Fig. 7, where subsystems S^1 and S^2 share a resource with capacity 2. S^1 , including the resource and ignoring S^2 , is the system from

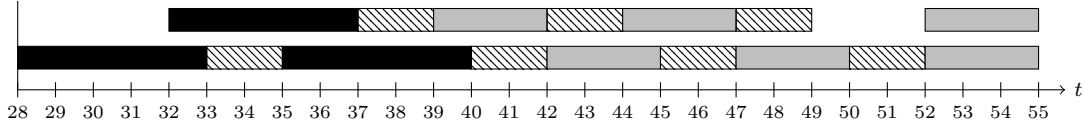

Fig. 6. Optimal schedules for S^1 and S^2 obtained in Example 18; the gray and black bars represent the operation of S^1 and S^2 , respectively, whereas the dashed bars are the delays imposed by the resource.

Example 11, whose transfer function is $G^1 = e\delta^3(2\delta^5)^*$ (cf. Section 2.3). For S^2 , we obtain $G^2 = e\delta^5(2\delta^7)^*$. In this example, $\beta = 2\delta^2$. The references $z^1 = e\delta^{42} \oplus 1\delta^{46} \oplus 3\delta^{54} \oplus 6\delta^{+\infty}$ and $z^2 = e\delta^{39} \oplus 1\delta^{50} \oplus 2\delta^{54} \oplus 3\delta^{+\infty}$ are given. As S^1 has the highest priority, we can simply compute $u_{\text{opt}}^1 = x_{A_{\text{opt}}}^1 = G^1 \natural z^1$, which is the same counter as u_{opt} obtained in Example 11. To determine $x_{A_{\text{opt}}}^2$, we follow the procedure described in this section. Computing the greatest fixed point of Φ^2 as in (10), we get $x_{A_{\text{opt}}}^2 = e\delta^{27} \oplus 1\delta^{31} \oplus 2\delta^{34} \oplus 3\delta^{+\infty}$ ($= u_{\text{opt}}^2$) and $x_{R_{\text{opt}}}^2 = e\delta^{32} \oplus 1\delta^{36} \oplus 2\delta^{39} \oplus 3\delta^{+\infty}$ ($= y_{\text{opt}}^2$), as shown in Fig. 6. Because the availability of the resource for S^2 is subject to the operation of S^1 , the firings of y^2 have to be given considerably earlier than required by z^2 ; this is, however, the latest they can be given so as to respect z^2 without interfering with S^1 . \diamond

4.3 Supplementary remarks

Proposition 19. (Adapted from Hardouin et al. (2008)) Let $\tilde{\Sigma} = \{s \in \Sigma \mid (\forall t \in \mathbb{Z}) s(t) \notin \{\varepsilon, \top\}\}$. For any $a \in \tilde{\Sigma}$, the mapping $\Pi_a : \Sigma \rightarrow \Sigma$, $x \mapsto a \odot x$, is dually residuated. For any $b \in \Sigma$, $\Pi_a^b(b)$, denoted $b \odot^b a$, is the least $x \in \Sigma$ such that $a \odot x \succeq b$.

Proof. For an arbitrary $a \in \tilde{\Sigma}$, we have $(\forall t \in \mathbb{Z}) a(t) \otimes \top = \top$, therefore $\Pi_a(s_{\top}) = a \odot s_{\top} = s_{\top}$. Moreover, since \odot distributes over \wedge (cf. Def. 16), for any $\mathcal{A} \subseteq \Sigma$ it holds that $\Pi_a(\bigwedge_{x \in \mathcal{A}} x) = a \odot (\bigwedge_{x \in \mathcal{A}} x) = \bigwedge_{x \in \mathcal{A}} (a \odot x) = \bigwedge_{x \in \mathcal{A}} \Pi_a(x)$. The result then follows from Theorem 10. \square

Remark 20. (Hardouin et al. (2008)) Given two counters $x_1, x_2 \in \Sigma$, the series $s \in \overline{\mathbb{Z}}_{\min}[\delta]$ defined by $(\forall t \in \mathbb{Z}) s(t) = x_1(t) - x_2(t)$ is not necessarily a counter; $x_1 \odot^{\#} x_2$ is the greatest counter lower than or equal to s . Similarly, provided $x_2 \in \tilde{\Sigma}$ (cf. Proposition 19), $x_1 \odot^b x_2$ is the least counter greater than or equal to s . \diamond

Remark 21. Since we take a term like $\eta\delta^\tau$ to mean that a transition has accumulated η firings by time τ , it is reasonable to assume that the counters u , x_i , and y are elements of $\tilde{\Sigma}$. Note, additionally, that for any finite subset $\mathcal{B} \subseteq \tilde{\Sigma}$ one has $\bigotimes_{s \in \mathcal{B}} s \in \tilde{\Sigma}$ and $\bigodot_{s \in \mathcal{B}} s \in \tilde{\Sigma}$. \diamond

5. OPTIMAL CONTROL OF TEGS WITH RESOURCE SHARING AND OUTPUT-REFERENCE UPDATE

In this section, as the main contribution of this paper, we incorporate the ideas discussed in Section 3 to the class of systems studied in Section 4 by showing how to determine the optimal (just-in-time) control inputs in face of changes in the output-references for TEGs that share resources under a given priority policy. We again emphasize that, in this setting, the overall system is not a TEG. The assumptions made in Section 4 are still in place.

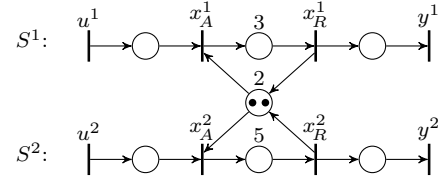

Fig. 7. Two TEGs sharing a resource with capacity 2.

5.1 Problem formulation

Consider the system from Fig. 4 and assume every subsystem S^k is operating optimally with respect to its own output-reference z^k , according to the priority-based strategy introduced in Section 4. Now, suppose that at time T each S^k has its reference z^k updated to $z^{k'}$ (with the possibility that $z^{k'} = z^k$ for some of them). Analogously to Section 3, we seek, for each k , the input $u_{\text{opt}}^{k'}$ which leads the corresponding output to optimally track $z^{k'}$ while preserving the input u_{opt}^k up to time T . The crucial difference is that now the priority scheme must be observed and, furthermore, the past resource allocations by subsystems with lower priority must also be respected. Such allocations are relevant — despite having occurred before time T — because the respective resource releases may take place after T , thus influencing the availability of the resource in the meantime.

For the purpose of the discussion to follow, let us fix an arbitrary $k \in \{1, \dots, K\}$. When updating the input of S^k , we must ensure minimal interference of lower-priority subsystems while respecting the past. Note that, for any $j \in \{k+1, \dots, K\}$, firings of x_A^j that were originally scheduled (according to $x_{A_{\text{opt}}}^j$) but have not taken place by time T can still be postponed (and hence, from the point of view of S^k , ignored). For the sake of determining $u_{\text{opt}}^{k'} = x_{A_{\text{opt}}}^{k'}$, we therefore take into account the firings of transition x_A^j that have occurred up to time T , but neglect all its prospective firings thenceforth; recalling Remark 13, this is precisely captured by the counter $r_T^{\#}(x_{A_{\text{opt}}}^j)$. In sum,

- (i) we must compute $x_{A_{\text{opt}}}^{k'}$ in decreasing order of priority;
- (ii) when calculating $x_{A_{\text{opt}}}^{k'}$ for $k > 1$, we must consider $x_{A_{\text{opt}}}^{i'}$ for every $i \in \{1, \dots, k-1\}$;
- (iii) when calculating $x_{A_{\text{opt}}}^{k'}$ for $k < K$, we must consider $r_T^{\#}(x_{A_{\text{opt}}}^j)$ for every $j \in \{k+1, \dots, K\}$.

It will be convenient to define the following terms:

$$\mathcal{H}_A^k = \bigodot_{i=1}^{k-1} x_{A_{\text{opt}}}^{i'}, \quad \mathcal{H}_R^k = \bigodot_{i=1}^{k-1} (G^i \otimes x_{A_{\text{opt}}}^{i'}),$$

$$\mathcal{L}_A^k = \bigodot_{j=k+1}^K r_T^{\#}(x_{A_{\text{opt}}}^j), \quad \mathcal{L}_R^k = \bigodot_{j=k+1}^K (G^j \otimes r_T^{\#}(x_{A_{\text{opt}}}^j)).$$

\mathcal{H}_A^k combines the counters $x_{A_{\text{opt}}}^{i'}$ of all subsystems S^i with priority higher than that of S^k , referring to the already-updated optimal schedules of resource-allocation transitions x_A^i with respect to the corresponding updated references $z^{i'}$; accordingly, \mathcal{H}_R^k combines the counters $x_{R_{\text{opt}}}^{i'} = G^i \otimes x_{A_{\text{opt}}}^{i'}$ representing the respective resource-release events. In a similar way, \mathcal{L}_A^k combines the counters $r_T^\#(x_{A_{\text{opt}}}^j)$ of all subsystems S^j with priority lower than that of S^k , representing the past firings (up to time T) of resource-allocation transitions x_A^j and neglecting their firings after time T , whereas \mathcal{L}_R^k gathers the respective resource-release events by combining the counters $G^j \otimes r_T^\#(x_{A_{\text{opt}}}^j)$; it should be emphasized that, even though we only consider the resource allocations by S^j up to time T , the respective resource-release events may take place after T , so in general one may have $G^j \otimes r_T^\#(x_{A_{\text{opt}}}^j) \neq r_T^\#(x_{R_{\text{opt}}}^j)$.

Thus, based on (6) and on the foregoing discussion, it must hold for each k that

$$\beta \otimes (\mathcal{H}_R^k \odot (G^k \otimes x_A^k) \odot \mathcal{L}_R^k) \preceq (\mathcal{H}_A^k \odot x_A^k \odot \mathcal{L}_A^k), \quad (\star)$$

where it is understood that for $k = 1$ (resp. $k = K$), the degenerate terms \mathcal{H}_A^1 and \mathcal{H}_R^1 (resp. \mathcal{L}_A^K and \mathcal{L}_R^K) are to be neglected. The problem of determining the new optimal input $u_{\text{opt}}^{k'}$ (based on $x_{A_{\text{opt}}}^{k'}$) with respect to a reference $z^{k'}$ given at time T can be formulated as follows: find the greatest element of the set

$$\mathcal{F}^k = \{x_A^k \in \Sigma \mid G^k \otimes x_A^k \preceq z^{k'} \text{ and } (\star) \text{ and } r_T(x_A^k) = r_T(x_{A_{\text{opt}}}^k)\}. \quad (11)$$

Remark 22. It should be clear that, for any $k \in \{1, \dots, K\}$, if $z^{i'} = z^i$ for all $i \in \{1, \dots, k\}$, then $x_{A_{\text{opt}}}^{i'} = x_{A_{\text{opt}}}^i$ for all $i \in \{1, \dots, k\}$. Nonetheless, if $z^{i'} \neq z^i$ for some $i < k$, in general it may be that $x_{A_{\text{opt}}}^{k'} \neq x_{A_{\text{opt}}}^k$ even if $z^{k'} = z^k$. \diamond

5.2 Optimal update of the inputs

Let us once more fix an arbitrary $k \in \{1, \dots, K\}$, and now assume $x_{A_{\text{opt}}}^{i'}$ has been determined for each (if any) $i \in \{1, \dots, k-1\}$. Similarly to Section 3, the set \mathcal{F}^k as defined in (11) may turn out to be empty; as (\star) and $r_T(x_A^k) = r_T(x_{A_{\text{opt}}}^k)$ are irrevocable, we will then seek the least way to relax $z^{k'}$ (i. e., look for the least counter $z^{k''} \succeq z^{k'}$) such that the set

$$\mathcal{F}_{z^{k''}}^k = \{x_A^k \in \Sigma \mid G^k \otimes x_A^k \preceq z^{k''} \text{ and } (\star) \text{ and } r_T(x_A^k) = r_T(x_{A_{\text{opt}}}^k)\}$$

is nonempty. Define the set

$$\tilde{\mathcal{F}}^k = \{x_A^k \in \Sigma \mid (\star) \text{ and } r_T(x_A^k) = r_T(x_{A_{\text{opt}}}^k)\}$$

and the mapping $\Upsilon^k : \Sigma \rightarrow \Sigma$,

$$\Upsilon^k(x) = [(\beta \otimes (\mathcal{H}_R^k \odot (G^k \otimes x) \odot \mathcal{L}_R^k)) \odot^\flat (\mathcal{H}_A^k \odot \mathcal{L}_A^k)] \oplus r_T(x_{A_{\text{opt}}}^k) \oplus x.$$

Note that, from Proposition 19 and Remark 21, the mapping $\Pi_{(\mathcal{H}_A^k \odot \mathcal{L}_A^k)}$ is dually residuated, so Υ^k is well defined. We now proceed to show that the least fixed point of Υ^k is an element of $\tilde{\mathcal{F}}^k$.

Proposition 23. $\bigwedge_{\Upsilon^k} \stackrel{\text{def}}{=} \bigwedge \{x \in \Sigma \mid \Upsilon^k(x) = x\} \in \tilde{\mathcal{F}}^k$.

Proof. Any $x_A^k \in \Sigma$ such that $\Upsilon^k(x_A^k) = x_A^k$ satisfies

$$(\beta \otimes (\mathcal{H}_R^k \odot (G^k \otimes x_A^k) \odot \mathcal{L}_R^k)) \odot^\flat (\mathcal{H}_A^k \odot \mathcal{L}_A^k) \preceq x_A^k$$

and, by consequence, also (\star) . According to Remark 3, \bigwedge_{Υ^k} is a fixed point of Υ^k , therefore (\star) holds for $x_A^k = \bigwedge_{\Upsilon^k}$ and it suffices to prove that $r_T(\bigwedge_{\Upsilon^k}) = r_T(x_{A_{\text{opt}}}^k)$.

\bigwedge_{Υ^k} being a fixed point of Υ^k implies $\bigwedge_{\Upsilon^k} \succeq r_T(x_{A_{\text{opt}}}^k)$, so $r_T(\bigwedge_{\Upsilon^k}) \succeq r_T(r_T(x_{A_{\text{opt}}}^k)) = r_T(x_{A_{\text{opt}}}^k)$.

Moreover, $r_T^\#(x_{A_{\text{opt}}}^k)$ is a fixed point of Υ^k , as can be seen from the following argument. Since we assume $x_{A_{\text{opt}}}^{i'}$ to be given for each $i \in \{1, \dots, k-1\}$, according to (\star) we know $x_{A_{\text{opt}}}^{(k-1)'}$ fulfills

$$\beta \otimes (\mathcal{H}_R^{(k-1)} \odot (G^{(k-1)} \otimes x_{A_{\text{opt}}}^{(k-1)'}) \odot \mathcal{L}_R^{(k-1)}) \preceq \mathcal{H}_A^{(k-1)} \odot x_{A_{\text{opt}}}^{(k-1)'}. \quad (12)$$

But note that

$$\begin{aligned} \mathcal{H}_R^{(k-1)} \odot (G^{(k-1)} \otimes x_{A_{\text{opt}}}^{(k-1)'}) &= \mathcal{H}_R^k, \\ \mathcal{L}_R^{(k-1)} &= (G^k \otimes r_T^\#(x_{A_{\text{opt}}}^k)) \odot \mathcal{L}_R^k, \\ \mathcal{H}_A^{(k-1)} \odot x_{A_{\text{opt}}}^{(k-1)'} &= \mathcal{H}_A^k, \quad \text{and} \\ \mathcal{L}_A^{(k-1)} &= r_T^\#(x_{A_{\text{opt}}}^k) \odot \mathcal{L}_A^k, \end{aligned}$$

so (12) is equivalent to

$$\beta \otimes (\mathcal{H}_R^k \odot (G^k \otimes r_T^\#(x_{A_{\text{opt}}}^k)) \odot \mathcal{L}_R^k) \preceq (\mathcal{H}_A^k \odot r_T^\#(x_{A_{\text{opt}}}^k) \odot \mathcal{L}_A^k)$$

which, in turn, implies

$$(\beta \otimes (\mathcal{H}_R^k \odot (G^k \otimes r_T^\#(x_{A_{\text{opt}}}^k)) \odot \mathcal{L}_R^k)) \odot^\flat (\mathcal{H}_A^k \odot \mathcal{L}_A^k) \preceq r_T^\#(x_{A_{\text{opt}}}^k).$$

This, together with the fact that $r_T^\#(x_{A_{\text{opt}}}^k) \succeq r_T(x_{A_{\text{opt}}}^k)$, imply $\Upsilon^k(r_T^\#(x_{A_{\text{opt}}}^k)) = r_T^\#(x_{A_{\text{opt}}}^k)$. Hence, $\bigwedge_{\Upsilon^k} \preceq r_T^\#(x_{A_{\text{opt}}}^k)$ and, as r_T is isotone and $r_T \circ r_T^\# = r_T$, we have $r_T(\bigwedge_{\Upsilon^k}) \preceq r_T(r_T^\#(x_{A_{\text{opt}}}^k)) = r_T(x_{A_{\text{opt}}}^k)$, which concludes the proof. \square

As clearly $\tilde{\mathcal{F}}^k \subseteq \{x \in \Sigma \mid \Upsilon^k(x) = x\}$, from Proposition 23 we conclude that

$$\underline{x}_A^k \stackrel{\text{def}}{=} \bigwedge_{x \in \tilde{\mathcal{F}}^k} x = \bigwedge_{\Upsilon^k}. \quad (13)$$

Proposition 24. The least counter $z^{k''} \succeq z^{k'}$ such that $\mathcal{F}_{z^{k''}}^k \neq \emptyset$ is $z^{k''} = z^{k'} \oplus (G^k \otimes \underline{x}_A^k)$.

Proof. Taking $z^{k''} = z^{k'} \oplus (G^k \otimes \underline{x}_A^k)$, it can be readily checked that $\underline{x}_A^k \in \mathcal{F}_{z^{k''}}^k$, therefore $\mathcal{F}_{z^{k''}}^k \neq \emptyset$; the proof then proceeds by direct analogy with that of Proposition 14. \square

Now, define the mapping $\Psi^k : \Sigma \rightarrow \Sigma$,

$$\Psi^k(x) = z^{k''} \wedge [(\beta \otimes (\mathcal{H}_R^k \odot x \odot \mathcal{L}_R^k)) \odot^\flat (\mathcal{H}_R^k \odot \mathcal{L}_R^k)],$$

with $z^{k''} = z^{k'} \oplus G^k \otimes \underline{x}_A^k$. Then, we can write

$$\mathcal{F}_{z^{k''}}^k = \{x \in \Sigma \mid G^k \otimes x \preceq \Psi^k(x) \text{ and } r_T(x) = r_T(x_{A_{\text{opt}}}^k)\}.$$

Based on Theorem 12 and recalling that $r_T^\# \circ r_T = r_T^\#$, we conclude that $x_{A_{\text{opt}}}^{k'}$ is the greatest $x \in \Sigma$ such that $x \preceq G^k \otimes \Psi^k(x) \wedge r_T^\#(x_{A_{\text{opt}}}^k)$, or, equivalently, $x = G^k \otimes \Psi^k(x) \wedge$

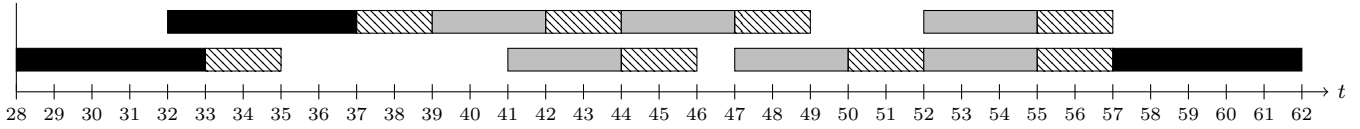

Fig. 8. Updated optimal schedules for S^1 and S^2 obtained in Example 25; the gray and black bars represent the operation of S^1 and S^2 , respectively, whereas the dashed bars are the delays imposed by the resource.

$r_T^\#(x_{A_{\text{opt}}}^k) \wedge x$. Finally, $x_{A_{\text{opt}}}^{k'}$ can be computed as the greatest fixed point of the (isotone) mapping $\Gamma^k : \Sigma \rightarrow \Sigma$,

$$\Gamma^k(x) = G^k \Psi^k(x) \wedge r_T^\#(x_{A_{\text{opt}}}^k) \wedge x. \quad (14)$$

Example 25. Consider the system from Example 18 (Fig. 7), with S^1 and S^2 both operating under the obtained optimal schedules. Now, suppose new references $z^{1'} = e\delta^{42} \oplus 1\delta^{43} \oplus 2\delta^{46} \oplus 3\delta^{54} \oplus 6\delta^{+\infty}$ and $z^{2'} = z^2$ are received at time $T = 33$. Observing the priority policy, we start by updating the input of S^1 . In this case, we have $\mathcal{L}_A^1 = r_T^\#(x_{A_{\text{opt}}}^2) = e\delta^{27} \oplus 1\delta^{31} \oplus 2\delta^{+\infty}$ and $\mathcal{L}_R^1 = G^2 \otimes r_T^\#(x_{A_{\text{opt}}}^2) = e\delta^{32} \oplus 1\delta^{36} \oplus 2\delta^{+\infty}$. Defining \mathcal{F}^1 as in (11), one can check that in this case $\mathcal{F}^1 \neq \emptyset$; then, $z^{1''} = z^{1'}$ and we can directly look for the greatest fixed point of Γ^1 (defined as in (14)), which is $x_{A_{\text{opt}}}^{1'} = e\delta^{38} \oplus 1\delta^{40} \oplus 2\delta^{43} \oplus 3\delta^{46} \oplus 4\delta^{51} \oplus 6\delta^{+\infty}$ ($= u_{\text{opt}}^{1'}$). Then, $x_{R_{\text{opt}}}^{1'} = e\delta^{41} \oplus 1\delta^{43} \oplus 2\delta^{46} \oplus 3\delta^{49} \oplus 4\delta^{54} \oplus 6\delta^{+\infty}$ ($= y_{\text{opt}}^{1'}$). We now proceed to update x_A^2 ; with $\mathcal{H}_A^2 = x_{A_{\text{opt}}}^{1'}$ and $\mathcal{H}_R^2 = x_{R_{\text{opt}}}^{1'}$, in this case $\mathcal{F}^2 = \emptyset$, so we look for the least $z^{2''} \succeq z^{2'}$ such that $\mathcal{F}_{z^{2''}}^2 \neq \emptyset$. According to (13), we obtain $\underline{x}_A^2 = e\delta^{27} \oplus 1\delta^{31} \oplus 2\delta^{56} \oplus 3\delta^{+\infty}$ and, from Proposition 24, $z^{2''} = z^{2'} \oplus (G^2 \otimes \underline{x}_A^2) = e\delta^{39} \oplus 1\delta^{50} \oplus 2\delta^{61} \oplus 3\delta^{+\infty}$. Computing the greatest fixed point of Γ^2 then yields $x_{A_{\text{opt}}}^{2'} = e\delta^{27} \oplus 1\delta^{31} \oplus 2\delta^{56} \oplus 3\delta^{+\infty}$ ($= u_{\text{opt}}^{2'}$) and $x_{R_{\text{opt}}}^{2'} = e\delta^{32} \oplus 1\delta^{36} \oplus 2\delta^{61} \oplus 3\delta^{+\infty}$ ($= y_{\text{opt}}^{2'}$). These updated optimal schedules are shown in Fig. 8. See that $x_{A_{\text{opt}}}^{2'} \neq x_{A_{\text{opt}}}^2$ even though $z^{2'} = z^2$ (cf. Remark 22). \diamond

5.3 Extension to more general cases

The results in this section are developed under the assumptions made in the beginning of Section 4. However, they can be readily extended to more general cases; namely, the same method can be applied to the case of multiple shared resources, and the simplifying assumptions on the connection between input and internal transitions, as well as between internal and output ones, can be dropped. For such generalizations in the framework of TEGs with shared resources but without output-reference update (Section 4), the reader may consult Moradi et al. (2017). The explicit generalization of the main results from this paper and a comprehensive case study are subjects for future work.

6. CONCLUSION

This paper solves the problem of ensuring that a number of TEGs competing for the use of shared resources operate optimally (in a just-in-time sense) even in face of changes in their output-references. The proposed method assumes a prespecified priority policy on the component TEGs, and the optimal inputs are computed under the rule that the operation of lower-priority subsystems cannot interfere with the performance of higher-priority ones. We also

study the case in which the limited availability of the resources renders it impossible to respect the updated output-reference for one or more of the subsystems. In this case, we show how to relax such references in an optimal way so that the ultimately obtained inputs lead to tracking them as closely as possible.

The results are illustrated through simple examples; exploiting the generality of the method and applying it to a larger, more practically-motivated case study, as well as investigating the flexibilization of the priority policy, are subjects for future work.

REFERENCES

- Addad, B., Amari, S., and Lesage, J.J. (2012). Networked conflicting timed event graphs representation in $(\max,+)$ algebra. *Discrete Event Dynamic Systems*, 22(4), 429–449.
- Allamigeon, X., Bœuf, V., and Gaubert, S. (2015). Performance evaluation of an emergency call center: tropical polynomial systems applied to timed petri nets. In *Formal Modeling and Analysis of Timed Systems (FORMATS 2015)*. Springer.
- Baccelli, F., Cohen, G., Olsder, G.J., and Quadrat, J.P. (1992). *Synchronization and Linearity: an Algebra for Discrete Event Systems*. Wiley.
- Blyth, T. and Janowitz, M. (1972). *Residuation Theory*. Pergamon press.
- Boussahel, W., Amari, S., and Kara, R. (2016). Analytic evaluation of the cycle time on networked conflicting timed event graphs in the $(\max,+)$ algebra. *Discrete Event Dynamic Systems*, 26(4), 561–581.
- Corréia, A., Abbas-Turki, A., Bouyekhf, R., and El Moudni, A. (2009). A dioid model for invariant resource sharing problems. *IEEE Transactions on Systems, Man, and Cybernetics*, 39(4), 770–781.
- Hardouin, L., Cottenceau, B., Lagrange, S., and Le Corronc, E. (2008). Performance analysis of linear systems over semiring with additive inputs. In *9th International Workshop on Discrete Event Systems (WODES)*. Göteborg, Sweden.
- Hardouin, L., Cottenceau, B., Shang, Y., and Raisch, J. (2018). Control and state estimation for max-plus linear systems. *Foundations and Trends in Systems and Control*, 6(1), 1–116.
- Menguy, E., Boimond, J.L., Hardouin, L., and Ferrier, J.L. (2000). Just-in-time control of timed event graphs: update of reference input, presence of uncontrollable input. *IEEE Transactions on Automatic Control*, 45(11), 2155–2159.
- Moradi, S., Hardouin, L., and Raisch, J. (2017). Optimal control of a class of timed discrete event systems with shared resources, an approach based on the hadamard product of series in dioids. In *56th IEEE Conference on Decision and Control (CDC)*. Melbourne, Australia.